

Catalogue
2020



Download your copy!

MUJI
無印良品





Select product codes & call or contact us on
WhatsApp for business: +9651821212
WhatsApp direct: +96597264813



Home Delivery - Processed and shipped between **2 to 6 business days**
Excluding Fridays & public holidays.

Delivery cost is KD 3 or *Free delivery* on orders *KD 8 and above.*

What is MUJI?

“NO LABEL. QUALITY GOODS”

MUJI is derived from its Japanese name ‘Mujirushi Ryohin’ which means ‘no label quality goods’. The brand launched in Japan in the 1980s with its no label, value-led, less is more concept.

MUJI is a renowned producer of stylish, functional and affordable quality goods that are relevant to all aspects of urban living, whether at work, rest or play.

Today MUJI has more than 800 stores worldwide and offers various consumer related products, including; household goods, stationery, travel accessories, beauty products and fashion.

In the Middle East, MUJI has stores in Kuwait, UAE, KSA, Bahrain, Qatar and Oman.



MUJI Philosophy & Values

Philosophy

- 1. Selection of materials:**
We use many recycled materials, with an emphasis on quality. This enables us to create low-priced, high-quality products.
- 2. Streamlining processes:**
Processes that have no bearing on a product's quality such as sorting, sizing, and polishing are eliminated. Focusing on true quality, MUJI's processes eliminate waste and reduce costs.
- 3. Simplification of packaging:**
MUJI seeks to highlight products' natural colors and shapes. MUJI products appear in simple packaging bearing only product related information and a price tag.

Values

- 1.** MUJI is not a brand whose value rests in the frills and "extras"
- 2.** MUJI is simplicity – but a simplicity achieved through a complexity of thought and design
- 3.** MUJI's streamlining is the result of careful elimination of gratuitous features and design unrelated to function
- 4.** MUJI, the brand, is rational, and free of agenda, doctrine, and "isms"
- 5.** MUJI aspires to modesty and plainness, to appeal to a wide group of people



BEST SELLERS!

★ Aroma Diffuser



Ultrasonic Aroma Diffuser

4547315880621 / Small -

29.00 KD, 315.00 SAR/AED, 299.00 QR, 35.00 BD/OMR

The ultrasonic waves spread the aroma to enjoy together with the lights. The white cylinder houses a lamp that shines with an ambient glow and has 2 light settings.

Ultrasonic Aroma Diffuser

4549738380283 / Large -

39.00 KD, 415.00 SAR/AED, 399.00 QR, 45.00 BD/OMR

Plenty of mist with pleasure of aroma even in a large room. 3-2 drops of essential oils for 100ml of water

★ Essential Oils

Herb & Flower

Herb aroma is recommended for relaxing.



★ Lemongrass

4550002546663 30 ml

11.00 KD, 130.00 AED/SAR/QR, 13.00 BD/OMR

Its sharp refreshing scent produces a cooling sensation. It is known that insects show aversion to the smell.



★ Lavender

4550002546625 30 ml

11.00 KD, 130.00 AED/SAR/QR, 13.00 BD/OMR

Its woody based gentle floral scent eases tension and has calming effect.

★ Gusset Case Collection

This cloth gusset case can be used to store and organise bulky clothes when travelling. It can be folded into a pocket size so as to save space.

L-4550002868956 | 40 x 53 x 10 cm

6.50 KD, 80.00 SAR/AED, 80.00 QR, 7.75 BD/OMR



★ Floor Chair

This simple floor chair matches any kind of room.

A legless chair with covering. With 6-step reclining function.

4548718481286 | L, W 57 x D 102 x H 10 cm,

21.00 KD, 300.00 SAR/AED/QR, 27.00 BD/OMR



Cotton Canvas Cover For Floor Chair

12.00 KD, 100.00 SAR/AED, 75.00 QR, 14.00 BD/OMR

4549337746886 - Ecru



4547315999699 - Dark Brown



4547315999057 - Beige



★ Down Blend Pillow

4549738994428 | 50 x 70 cm

30.00KD ,420.00 AED/SAR , 400.00 QR, 35 BD/OMR



★ Pp Storage Case Drawer / Wide Deep

4548718182800 14.00 KD, 170.00 SAR/AED, 160.00 QR, 17.00 BD/OMR

Approx. W 55 x D 44.5 x H 30 cm



★ Acrylic Stand For Glasses

4934761174280 | 16.00 KD, 185.00 SAR/AED, 175 QR, 19 BD/OMR

Approx. W 6.7 x D 17.5 x H 25 cm



★ Acrylic Stand For Glasses

4549738970125 | 16.00 KD, 195.00 SAR/AED, 185.00 QR, 19.00 BD/OMR

Approx. W 25.5 x D 17 x H 9.5 cm



★ Acrylic Box 2 Drawer / L

4549738300397 | 16.00 KD, 195.00 SAR/AED, 185.00 QR, 19.00 BD/OMR

Approx. W 25.5 x D 17 x H 9.5 cm



★ Velour Partition

Velour Partition 3 x 5 / Grey

4549738373544 | 6.00 KD, 70.00

SAR/AED/QR, 8.00 BD/OMR

Approx. W 15.5 x D 12 x H 2.5 cm

Velour With Ring Partition / L / Grey

4549738373551 | 6.00 KD, 90.00 SAR/AED,

85.00 QR, 7.00 BD/OMR

Approx. W 23.5 x D 15.5 x H 2.5 cm



★ PP Storage Case Drawer / Wide / L

4945247266740 | 12.50 KD, 145.00 SAR/AED, 135.00 QR, 16.00 BD/OMR

Approx. W 55 x D 44.5 x H 24 cm



★ PP Storage Case Drawer / Wide / M / 4 Row

4548718510269 | 30.00 KD, 370.00 SAR/AED, 350.00 QR, 40.00 BD/OMR

Approx. W 55 x D 44.5 x H 90 cm



Household



Buri Storage Unit 13



Rattan Storage Unit 14



Cotton Linen Storage Unit 15



Polypropylene Storage Box 17



Stacking Shelf 25



Furniture 29



Acrylic Storage Units 3



Makeup PP Storage 9



Tableware 47



Housekeeping 59

Acrylic Storage Unit

Acrylic storage units feature scratch resistance as well as transparency that allows you to identify the contents from the outside. MUJI offers a wide variety of acrylic storage units suitable for any purpose or space, such as desktop or the living room.



Acrylic Box 2 Drawer / L

4549738300397
 16.00 KD, 195.00 SAR/AED,
 185.00 QR, 19.00 BD/OMR
 Approx. W 25.5 x D 17 x H 9.5 cm
 * Stacking limit: 2 units



Acrylic Box 2 With Lid 2 Drawer / L

4549738970125
 16.00 KD, 195.00 SAR/AED,
 185.00 QR, 19.00 BD/OMR
 Approx. W 25.5 x D 17 x H 9.5 cm
 * Stacking limit: 2 units



Acrylic Box 5 Drawer

4547315915491
 20.00 KD, 240.00 SAR/AED,
 225.00 QR, 23.00 BD/OMR
 Approx. W 25.5 x D 17 x H 16 cm
 * Stacking limit: 2 units



Acrylic Box 3 Drawer

4547315915507
 16.00 KD, 185.00 SAR/AED,
 175.00 QR, 19.00 BD/OMR
 Approx. W 25.5 x D 17 x H 10 cm
 * Stacking limit: 2 units



Acrylic Box 2 Drawer

4945247380910
 11.00 KD, 135.00 SAR/AED,
 125.00 QR, 14.00 BD/OMR
 Approx. W 17.5 x D 13 x H 9.5 cm
 * Stacking limit: 2 units



Acrylic Box With Lid 2 Drawer

4945247380965
 11.00 KD, 135.00 SAR/AED,
 125.00 QR, 14.00 BD/OMR
 Approx. W 17.5 x D 13 x H 9.5 cm
 * Stacking limit: 2 units



Acrylic Storage Box 3 Drawer

4549738907589
 21.00 KD, 250.00 SAR/AED,
 225.00 QR, 28.00 BD/OMR
 A4



Acrylic Box 6 Drawers A4

4549738907572
 24.00 KD, 300.00 SAR/AED,
 285.00 QR, 27.00 BD
 A4



Acrylic Rack L

4547315296309
 9.00 KD, 105.00 SAR/AED, 100.00
 QR, 11.00 BD/OMR
 Approx. W 17.5 x D 13 x H 14.3 cm



Usage example



Acrylic Rack S

4547315296286
 7.50 KD, 90.00 SAR/AED, 85.00
 QR, 10.00 BD/OMR
 Approx. W 8.8 x D 13 x H 4.3 cm



Usage example



Acrylic Stand For Pierced Earrings & Necklaces

4548718958207
 11.00 KD, 135.00 SAR/AED,
 125.00 QR, 14.00 BD/OMR
 Approx. W 6.7 x D 13 x H 25 cm



Usage example



Acrylic Stand For Glasses

4934761174280
 16.00 KD, 185.00 SAR/AED,
 175 QR, 19.00 BD/OMR
 Approx. W 6.7 x D 17.5 x H 25 cm



Usage example



Stackable Acrylic Box / Cover For Tissues
4550002855963
1.50 KD, 20.00 SAR/AED/QR,
1.75 BD/OMR
Approx. L: W 24.6 × H 12 cm



Stackable Acrylic Box / Tray
4550002856083
1.250 KD, 15.00 SAR/AED/QR,
1.50 BD/OMR
Approx. W 25.9 × D 9.1 × H 1.3 cm



Stackable Acrylic Box / Lid
4550002856076
0.50 KD, 7.00 SAR/AED/QR,
0.75 BD/OMR
Approx. W 8.4 × D 8.4 cm



Stackable Acrylic Box / M
4550002855918
5.00 KD, 60.00 SAR/AED/QR,
6.00 BD/OMR
Approx. W 25.2 × D 12.6 × H 8 cm



Acrylic Display Case With Sliding Doors / L
4550002856113
12.00 KD, 150.00 SAR/AED/QR,
15.00 BD/OMR
Approx. L: W 33.6 × D 8.4 × H 24.4 cm
S: W 25.2 × D 8.4 × H 18.4 cm



Acrylic 6 Drawer
4549337268142
20.00 KD, 240.00 SAR/AED,
225.00 QR, 23.00 BD/OMR
Approx. W 8.7 × D 17 × H 25.2 cm



Acrylic 3 Drawer
4934761798202
16.00 KD, 185.00 SAR/AED,
175.00 QR, 19.00 BD/OMR
Approx. W 8.7 × D 17 × H 25.2 cm



Acrylic Unit - 1 Drawer
4934761798196
11.00 KD, 135.00 SAR/AED,
125.00 QR, 14.00 BD/OMR
Approx. W 25.2 × D 17 × H 8.7 cm

Stackable Acrylic Box / L
4550002855901
6.50 KD, 80.00 SAR/AED/QR,
8 BD/OMR
Approx. L: W 25.2 × D 12.6 × H 16 cm

Stackable Acrylic Box / L / Half
4550002855932
4.50 KD, 50.00 SAR/AED/QR,
5.5 BD/OMR
Approx. W 12.8 × D 12.8 × H 16 cm

Stackable Acrylic Box / L / Small
4550002856045
1.750 KD, 25.00 SAR/AED/QR,
2.25 BD/OMR
Approx. W 8.4 × D 8.4 × H 9 cm



Stackable Acrylic Box / M / Half
4550002855949
3.50 KD, 40.00 SAR/AED/QR,
4.5 BD/OMR
Approx. W 12.6 × D 12.6 × H 8 cm



Stackable Acrylic Box / M / Small
4550002856052
1.50 KD, 20.00 SAR/AED/QR,
1.75 BD/OMR
Approx. W 8.4 × D 8.4 × H 6 cm



Stackable Acrylic Box / S
4550002855925
3.50 KD, 40.00 SAR/AED/QR,
4.5 BD/OMR
Approx. W 25.2 × D 12.6 × H 4 cm



Stackable Acrylic Box / S / Half
4550002855956
2.50 KD, 30.00 SAR/AED/QR,
3.5 BD/OMR
Approx. W 12.6 × D 12.6 × H 4 cm

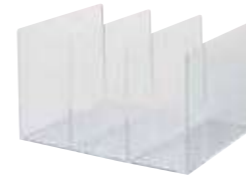

Acrylic Divider / L
4547315902194
9.00 KD, 105.00 SAR/AED,
100.00 QR, 11.00 BD/OMR
Approx. W 26.8 × D 21 × H 16 cm



Acrylic Divider / S
4547315902200
7.50 KD, 90.00 SAR/AED, 85 QR,
10.00 BD/OMR
Approx. W 13.3 × D 21 × H 16 cm



Acrylic Case For Glasses
4549738671497
17.00 KD, 200.00 SAR/AED/QR,
23.00 BD/OMR
Closed: Approx. W 17.5 × D 8.8 × H 25 cm
Opened: Approx. W 35 × D 4.4 × H 25 cm



Acrylic Stand For Letters / Wide
4550002856168
4.00 KD, 50.00 SAR/AED/QR,
5.00 BD/OMR
Approx. W 8.7 × D 13 × H 13 cm



Stackable Acrylic Box / S / Small
4550002856069
1.250 KD, 15.00 SAR/AED/QR,
1.5 BD/OMR
Approx. W 8.4 × D 8.4 × H 3 cm



Stackable Acrylic Box 1
4550002855994
1.50 KD, 20.00 SAR/AED/QR,
1.75 BD/OMR
Approx. W 12 × D 12 × H 7.2 cm



Stackable Acrylic Box 3
4550002856014
1.00 KD, 10.00 SAR/AED/QR,
1.25 BD/OMR
Approx. W 12 × D 12 × H 3.3 cm



Stackable Acrylic Shoes Case
4550002856144
15.00 KD, 200.00 SAR/AED/QR,
15.00 BD/OMR
Approx. W 25 × D 32 × H 12.5 cm



Acrylic Pen Pot Rectangular
4549337528574
1.50 KD, 20.00 SAR/AED,
15.00 QR, 2.00 BD/OMR
Approx. W 5.5 × D 4.5 × H 9 cm



Acrylic Stand With Partition
4934761407845
11.00 KD, 135.00 SAR/AED, 125 QR,
14.00 BD/OMR
Approx. W 25.8 × D 17.5 × H 6.1 cm
* Stacking limit: 2 units



Acrylic Storage / 3 Tiers
4549337318533
9.00 KD, 105.00 SAR/AED, 100 QR,
11.00 BD/OMR
Approx. W 17.5 × D 6.5 × H 23 cm
* Do not store oil-based solutions, such as essential oils and body oils, in this stand.



Stackable Acrylic Box / Cover for Paper Towels
4550002855970
1.750 KD, 25.00 SAR/AED/QR,
2.25 BD/OMR
Approx. W 24.8 × D 12 × H 3 cm
* Do not store oil-based solutions, such as essential oils and body oils, in this stand.



Stackable Acrylic Box / Divider
4550002856106
1.250 KD, 15.00 SAR/AED/QR,
1.5 BD/OMR
Approx. W 5.8 × D 8.4 × H 5.7 cm



Stackable Acrylic Box / Desktop Card Box
4550002856090
1.250 KD, 15.00 SAR/AED/QR,
1.5 BD/OMR
Approx. W 10 × D 8.4 × H 4.5 cm



Acrylic Partition Shelf / L
4547315919840
5.50 KD, 70.00 SAR/AED,
65.00 QR, 7.00 BD/OMR
Approx. W 26 × D 17.5 × H 16 cm



Acrylic Partition Shelf / S
4547315919833
4.250 KD, 50.00 SAR/AED,
45.00 QR, 5.00 BD/OMR
Approx. W 26 × D 17.5 × H 10 cm



Acrylic Smart Phone Stand / L
4550002856212
4.00 KD, 50.00 SAR/AED/QR,
5.00 BD/OMR
Approx. W 16.8 × D 8.4 × H 9 cm



Acrylic Smart Phone Stand / S
4550002856229
3.50 KD, 40.00 SAR/AED/QR,
4.5 BD/OMR
Approx. W 8.4 × D 8.4 × H 9 cm



Velour Partition / Grey

4549738373575
3.50 KD, 50.00 SAR/AED, 45.00 QR, 4.00 BD/OMR
Approx. W 15.5 x D 12 x H 2.5 cm



Usage example



Velour Partition 3 x 5 / Grey

4549738373544
6.00 KD, 70.00 SAR/AED/QR, 8.00 BD/OMR
Approx. W 15.5 x D 12 x H 2.5 cm



Usage example



Velour Partition Large / Grey

4549738373568
6.00 KD, 90.00 SAR/AED, 85.00 QR, 7.00 BD/OMR
Approx. W 23.5 x D 15.5 x H 2.5 cm



Usage example



Velour With Ring Partition Large / Grey

4549738373551
6.00 KD, 90.00 SAR/AED, 85.00 QR, 7.00 BD/OMR
Approx. W 23.5 x D 15.5 x H 2.5 cm



Usage example



Velour Case For Glass Stand Grey

Grey
4550002119577
2.50 KD, 30.00 SAR/AED/QR, 3.25 BD/OMR
Approx. W 3.7 x D 16.7 x H 2 cm



Usage example



Velour Case For Earring Stand Grey

4550002119560
2.50 KD, 30.00 SAR/AED/QR, 3.25 BD/OMR
Approx. W 3.7 x D 16.7 x H 2 cm



Usage example



PP Storage (Makeup)

You can choose the polypropylene makeup case best suited to what you want to store inside. Cases of the same size can be stacked and are ideal for storing small objects.



PP Makeup Box
4549337495548
3.250 KD, 45.00 SAR/AED/QR,
3.5 BD/OMR
Approx. W 15 × D 22 × H 16.9 cm



PP Makeup Box 1/2
4549337495555
2.250 KD, 35.00 SAR/AED/QR,
2.5 BD/OMR
Approx. W 15 × D 22 × H 8.6 cm



PP Nylon Makeup Box 1/4
4549337495562
1.50 KD, 25.00 SAR/AED/QR,
1.75 BD/OMR
Approx. W 15 × D 22 × H 4.5 cm



PP Makeup Tray Mirror
4549337495609
5.250 KD,
70.00 SAR/AED/
QR, 5.50 BD/
OMR
Approx. W 15 × D
22 × H 2 cm



Pp Makeup Tray
4549337495579
1.250 KD, 15.00 SAR/AED/QR,
1.75 BD/OMR
Approx. W 15 × D 22 × H 2 cm

This product can be placed both vertically and horizontally. Also can be used in place of a lid when combined with PP Vanity Cases.



PP Makeup Box W/Lid L
4549337495616
3.250 KD, 45.00 SAR/AED/QR,
3.5 BD/OMR
Approx. W 15 × D 22 × H 10.3 cm



PP Makeup Box W/Lid S
4549337495623
2.00 KD, 30.00 SAR/AED/QR,
2.25 BD/OMR
Approx. W 15 × D 11 × H 10.3 cm



PP Makeup Box Half / 1/2
Size W/Partition
4549337497696
2.00 KD, 30.00 SAR/AED/QR,
2.25 BD/OMR
Approx. W 15 × D 11 × H 8.6 cm



PP Makeup Box Half / 1/4
Size W/Partition
4549337497702
1.250 KD, 20.00 SAR/AED/QR,
1.5 BD/OMR
Approx. W 15 × D 11 × H 4.5 cm

PP Makeup Tray
4549337497689
0.9 KD, 10.00 SAR/AED/QR,
1.25 BD/OMR
Approx. S: W 15 × D 11 × H 2 cm
L: W 15 × D 22 × H 2 cm



PP Makeup Storage Box 1/2
Half
4549337495586
1.25 KD, 20.00 SAR/AED/QR,
1.5 BD/OMR
Approx. W 15 × D 11 × H 8.6 cm



PP Makeup Box Half / 1/4
Size
4549337497764
1.00 KD, 15.00 SAR/AED/QR,
1.25 BD/OMR
Approx. W 15 × D 11 × H 4.5 cm



PP Makeup Storage Box
1/4 Half
4549337495593
1.50 KD, 25.00 SAR/AED/QR,
1.75 BD/OMR
Approx. W 7.5 × D 22 × H 4.5 cm



PP Stand For Makeup Brush & Pencil
4549337497672
1.00 KD, 15.00 SAR/AED/QR,
1.25 BD/OMR
Approx. W 7.1 × D 7.1 × H 10.3 cm



PP Case For Cotton Buds With Lid
4549337495630
Approx. W 10.7 × D 7.2 ×
H 9.1 cm
1.25 KD, 20.00 SAR/AED/QR,
1.5 BD/OMR



PP Case For Cotton & Cotton Buds
4549337497665
Approx. W 10.7 × D 7.2 ×
H 7.7 cm
1.00 KD, 15.00 SAR/AED/QR,
1.25 BD/OMR

Usable as small compartment storage boxes inside drawers.

These can be used as small compartment storage boxes for drawers in polypropylene storage boxes. This makes them useful for neatly organising small office objects such as stationery and storing small items that tend to get separated easily. Features round corners that make it easy to remove items from inside and semi-transparent material that allows you to see objects from the sides.



Storage / Buri, Rattan & Cotton Linen



Interior Advisor's Recommendation.

The standard dimensions of modules are based on "shaku", which is a unit of measurement used in the construction of Japanese homes. These dimensions are used in a wide variety of items ranging from large furniture to small storage items. For example, the height of a unit shelf is based on the height of a "kamoi" (lintel) or door, and shelf width is based on the width of a half "ken" (91 cm), so that they can fit neatly within the width of 1 "ken" (182 cm), between two columns.

Unit shelf module dimensions "175 cm and 86 cm"

The 175 cm height corresponds the height of doors in Japanese homes. The 86 cm width is based on the "ken" (182 cm), which is a unit of measurement used in the construction of Japanese homes. "Outer width 86 cm, inner width 84 cm" which is slightly less than a half "ken" (91 cm), is a standard dimension for MUJI products.

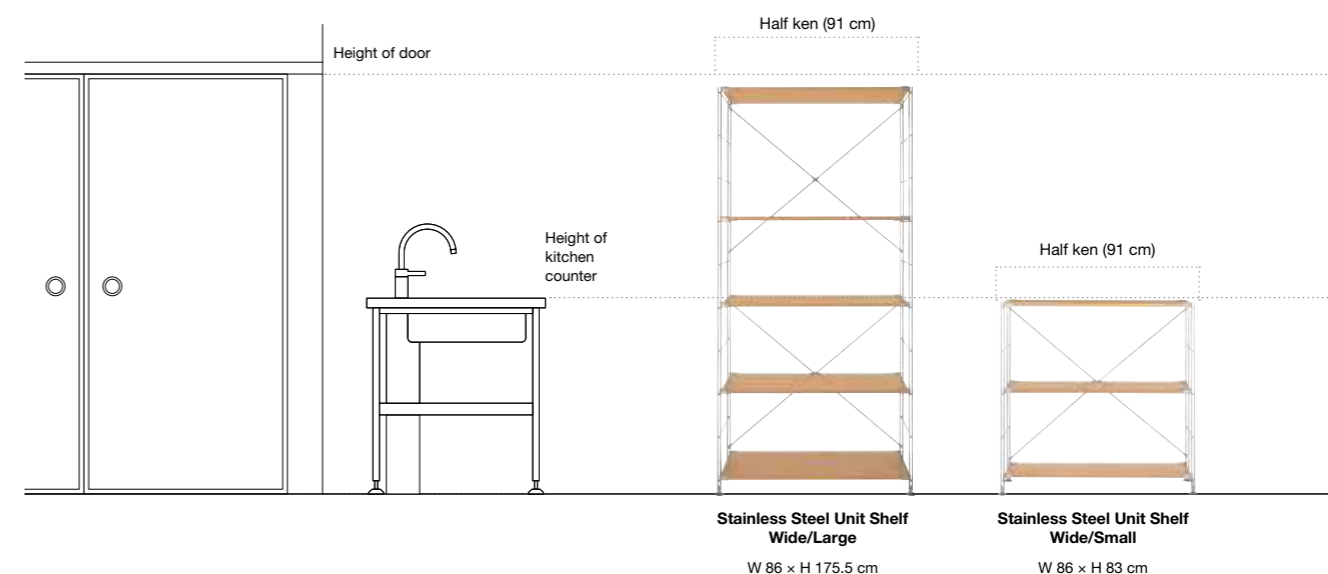

Storage item module dimensions "37 cm and 26 cm"

Storage item modules are sized to fit neatly in storage furniture with dimensions of 175 cm and 86 cm. The module dimensions of 26 cm and 37 cm, which are designed to fit on shelves, are based on the inside dimensions of shelves (W 80 x H 35 cm).

Compatible storage items

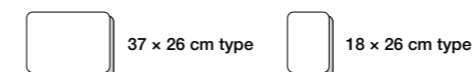

These modules fit in a unit shelf or stacking shelf.

These modules fit in a unit shelf.

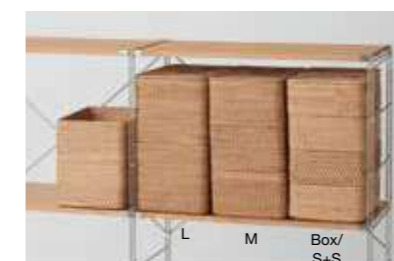

37 x 26 cm baskets arranged vertically



Arrangement of 37 x 37 cm baskets

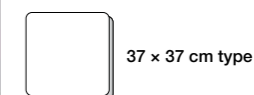

* Size varies depending on the material.

Buri Storage Unit

Hand-woven using high quality uncoated, unbleached buri from the Philippines that keeps its natural texture. Some of these highly functional storage baskets also come with lids and handles.



Stackable Buri Basket Rectangular / L

4548718014002
8.00 KD, 95.00 SAR/AED/QR,
10.00 BD/OMR
Approx. W 37 x D 26 x H 24 cm
A4



Stackable Buri Basket Rectangular / M

4945247027914
5.5 KD, 65.00 SAR/AED/QR,
7.00 BD/OMR
Approx. W 37 x D 26 x H 16 cm
A4



Stackable Buri Basket Rectangular / S

4945247027907
4.50 KD, 55.00 SAR/AED/QR,
5.75 BD/OMR
Approx. W 37 x D 26 x H 12 cm
A4



Stackable Buri Box Rectangular

4945247027921
3.00 KD, 40.00 SAR/AED/QR,
3.75 BD/OMR
Approx. W 26 x D 18.5 x H 12 cm

Buri Basket Lid / Rectangular

4548718014026
1.50 KD, 20.00 SAR/AED/QR,
2.00 BD/OMR
Approx. W 37 x D 26 x H 2 cm
* This lid can be used with S, M, and L buri baskets.

Buri Box Lid / Rectangular

4548718014033
1.00 KD, 15.00 SAR/AED/QR,
1.25 BD/OMR
Approx. W 26 x D 18.5 x H 2 cm



Buri Basket Square / XL

4945247027945
10.00 KD, 120.00 SAR/AED/QR,
13.00 BD/OMR
Approx. W 35 x D 37 x H 32 cm



Stackable Buri Basket Square / L

4548718013999
9.00 KD, 110.00 SAR/AED/QR,
12.00 BD/OMR
Approx. W 35 x D 37 x H 24 cm



Stackable Buri Basket Square / M

4945247027938
6.00 KD, 75.00 SAR/AED/QR,
7.5 BD/OMR
Approx. W 35 x D 37 x H 16 cm

Buri Basket Lid / Square

4548718014019
2.00 KD, 25.00 SAR/AED/QR,
2.5 BD/OMR
Approx. W 35 x D 37 x H 2 cm
* This lid can be used with M, L, and XL buri baskets.



The baskets come with sturdy frames and close fitting lids.

Rattan Storage Unit

Rattan storage is light and easy to handle, as well as smooth to the touch. These stackable storage items are designed for ease of use, with convenient lids and handles.



Stackable Rattan Basket Rectangular / L

4945247381313
15.00 KD, 180.00 SAR/AED,
175.00 QR, 19.00 BD/OMR
Approx. W 36 x D 26 x H 24 cm
A4



Stackable Rattan Basket Rectangular / M

4945247381306
12.50 KD, 145.00 SAR/AED,
140.00 QR, 16.00 BD/OMR
Approx. W 36 x D 26 x H 16 cm
A4



Stackable Rattan Basket Rectangular / S

4945247381290
11.00 KD, 125.00 SAR/AED,
120.00 QR, 14.00 BD/OMR
Approx. W 36 x D 26 x H 12 cm



Stackable Rattan Box With Lid Rectangular

4945247381337
12.00 KD, 140.00 SAR/AED,
135.00 QR, 15.5 BD/OMR
Approx. W 26 x D 18 x H 16 cm

Stackable Rattan Basket Lid Rectangular

4547315004768
5.00 KD, 60.00 SAR/AED, 55.00 QR, 6.5 BD/OMR
Approx. W 36 x D 26 x H 3 cm
* Can be used with L / M / or S.



Stackable Rattan Box Rectangular / S

4945247381238
11.00 KD, 125.00 SAR/AED,
120.00 QR, 14.00 BD/OMR
Approx. W 26 x D 18 x H 12 cm



Rattan Box With Handle

4945247028454
7.00 KD, 85.00 SAR/AED,
80.00 QR, 8.5 BD/OMR
Approx. W 15 x D 22 x H 9 cm



Stackable Rattan Basket Square / L

4548718021826
23.00 KD, 265.00 SAR/AED,
260.00 QR, 29.00 BD/OMR
Approx. W 35 x D 36 x H 24 cm



Stackable Rattan Basket Square / M

4548718021833
16.00 KD, 190.00 SAR/AED,
185.00 QR, 20.00 BD/OMR
Approx. W 35 x D 36 x H 16 cm



Rattan Tissue Box

4547315815746
11.00 KD, 130.00 SAR/AED,
125.00 QR, 14.00 BD/OMR
Approx. W 27.5 x D 14.5 x H 8.8 cm



Stackable Rattan Laundry Basket

4549738309819
19.00 KD, 225.00 SAR/AED/QR,
25.00 BD/OMR
Approx. W 36 x D 26 x H 32 cm

Country of origin of Rattan Basket

Rattan baskets sold by MUJI are made in Thai Binh province, northern Vietnam. Thai Binh province is a peaceful place with rice fields and free-range cows, buffalos, and chickens. In addition to farming, the area is also famous for its handcrafts, particularly items of woven rattan and bamboo.



Making a Rattan Basket

The rattan, about 3-5 cm in diameter, must first be split into 5-9 mm strips before it can be used to make a basket. The rattan baskets are woven by hand, by farmers. This rattan basket takes a long time to weave, only 1-2 can be made in a day.



* Usage example

Cotton Linen Storage Unit

Coated on the inside, these fabric boxes can be folded compactly. The boxes are made based on MUJI's original size standard, which allow them to be combined with shelves and other items.



Cotton-Linen Polyester
Soft Box Oblong / L
4549738369738
8.00 KD, 100.00 SAR/AED, 95.00 QR, 10.00 BD/OMR
Approx. W 37 x D 26 x H 34 cm
A4



Cotton-Linen Polyester
Soft Box Oblong / M With Lid
4549738369769
8.50 KD, 105.00 SAR/AED, 105.00 QR, 10.00 BD/OMR
Approx. W 37 x D 26 x H 26 cm
A4



Cotton-Linen Polyester
Soft Box Oblong / M
4549738369776
7.00 KD, 85.00 SAR/AED, 80.00 QR, 9.00 BD/OMR
Approx. W 37 x D 26 x H 26 cm
A4



Cotton-Linen Polyester
Soft Box Oblong / S
4549738369752
6.00 KD, 70.00 SAR/AED, 65.00 QR, 8.00 BD/OMR
Approx. W 37 x D 26 x H 16 cm
A4



Cotton-Linen Polyester Soft
Box L With Lid
4549738369721
11.00 KD, 130.00 SAR/AED, 125.00 QR, 14.00 BD/OMR
Approx. W 35 x D 35 x H 32 cm



Cotton-Linen Polyester Soft
Box / L
4549738369714
8.50 KD, 105.00 SAR/AED, 100.00 QR, 10.00 BD/OMR
Approx. W 35 x D 35 x H 32 cm



Cotton-Linen Polyester Soft
Box Cloth Case Large
4549738369707
13.00 KD, 135.00 SAR/AED, 130.00 QR, 16.00 BD/OMR
Approx. W 59 x D 39 x H 23 cm



Cotton-Linen Polyester Soft
Box Cloth Case
4549738369745
11.00 KD, 125.00 SAR/AED/QR, 14.00 BD/OMR
Approx. W 59 x D 39 x H 18 cm



Cotton Linen Polyester Soft
Box Rectangular / Half / M
4550002118815
4.25 KD, 50.00 SAR/AED/QR, 6.00 BD/OMR
Approx. W 18.5 x D 26 x H 26 cm



Cotton Linen Polyester Soft
Box Rectangular Box / L
4550002118822
11.00 KD, 130.00 SAR/AED/QR, 14.00 BD/OMR
Approx. W 65 x D 40 x H 26 cm



Cotton Linen Polyester Soft
Box Rectangular / S / With Zip
4550002118846
7.5 KD, 80.00 SAR/AED/QR, 9.5 BD/OMR
Approx. W 37 x D 26 x H 16 cm



Cotton Linen Polyester Soft
Box / XS / Half
4549738369660
3.00 KD, 35.00 SAR/AED/QR, 4.00 BD/OMR
Approx. W 13 x D 37 x H 12 cm
A4



Cotton Linen Polyester Soft
Box Rectangular / Half / L
4550002118792
3.75 KD, 45.00 SAR/AED/QR, 5.00 BD/OMR
Approx. W 17.5 x D 35 x H 32 cm



Cotton Linen Polyester Soft
Box Rectangular / Half / L / With Lid
4550002118785
5.00 KD, 60.00 SAR/AED/QR, 6.5 BD/OMR
Approx. W 17.5 x D 35 x H 32 cm



Cotton-Linen Polyester Soft
Box Oblong / S / Half
4549738369677
3.25 KD, 40.00 SAR/AED/QR, 4.25 BD/OMR
Approx. W 18.5 x D 26 x H 16 cm



Cotton-Linen Polyester Soft
Box Square / S
4549738369684
6.50 KD, 65.00 SAR/AED, 60.00 QR, 9.00 BD/OMR
Approx. W 35 x D 35 x H 16 cm



Cotton-Linen Polyester Soft
Box Square / S with Lid
4549738369691
7.50 KD, 80.00 SAR/AED, 75.00 QR, 10.00 BD/OMR
Approx. W 35 x D 35 x H 16 cm



Soft Box / With Zip / Small
Equipped with partitions, these are handy for organising items that easily lose their shape.

* Cotton linen polyester storage items are non-washable.

Polypropylene Storage Unit

There is a wide range of cases, stockers, and boxes.
Flexibly combine the items and sizes according to your purpose and available space.



A large drawer-type case that fits perfectly into your closet.

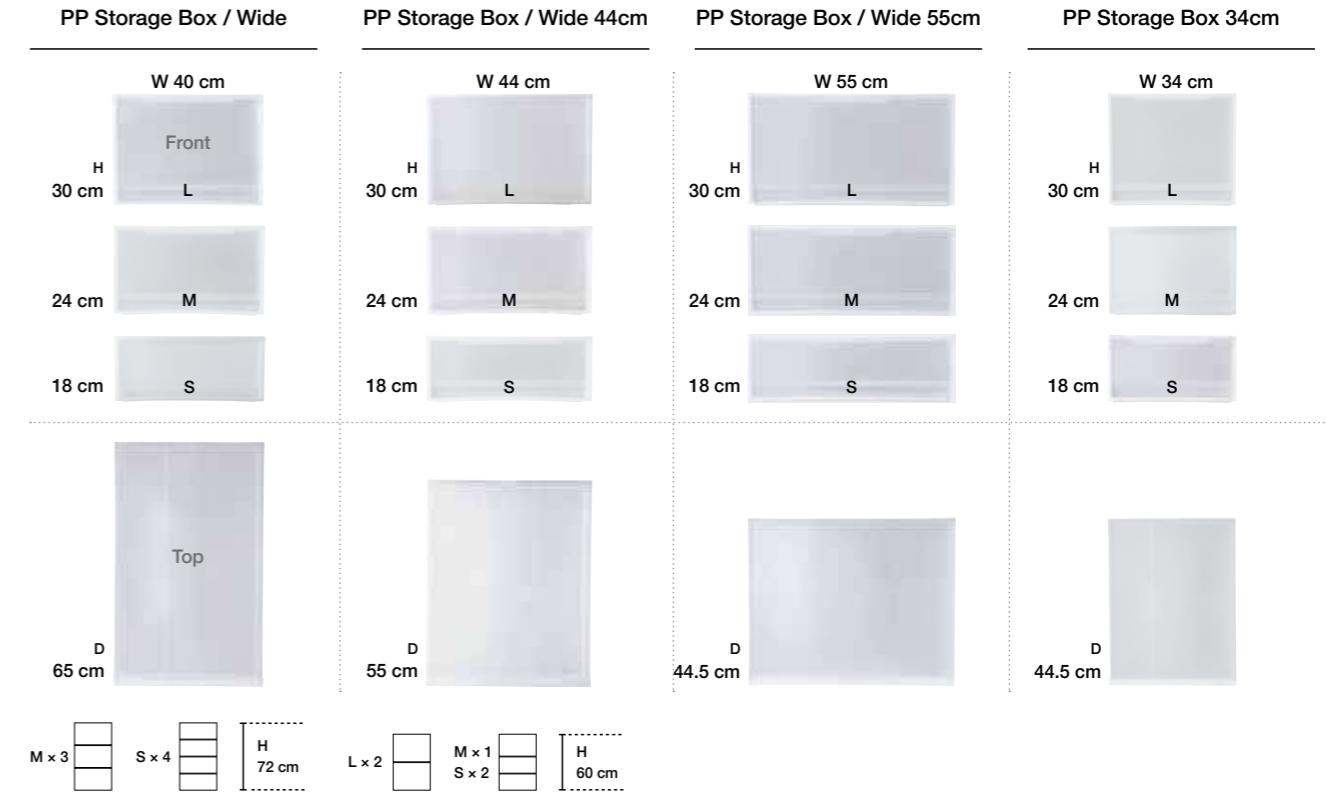

A drawer-type case that can be stacked or fit perfectly into storage furniture.

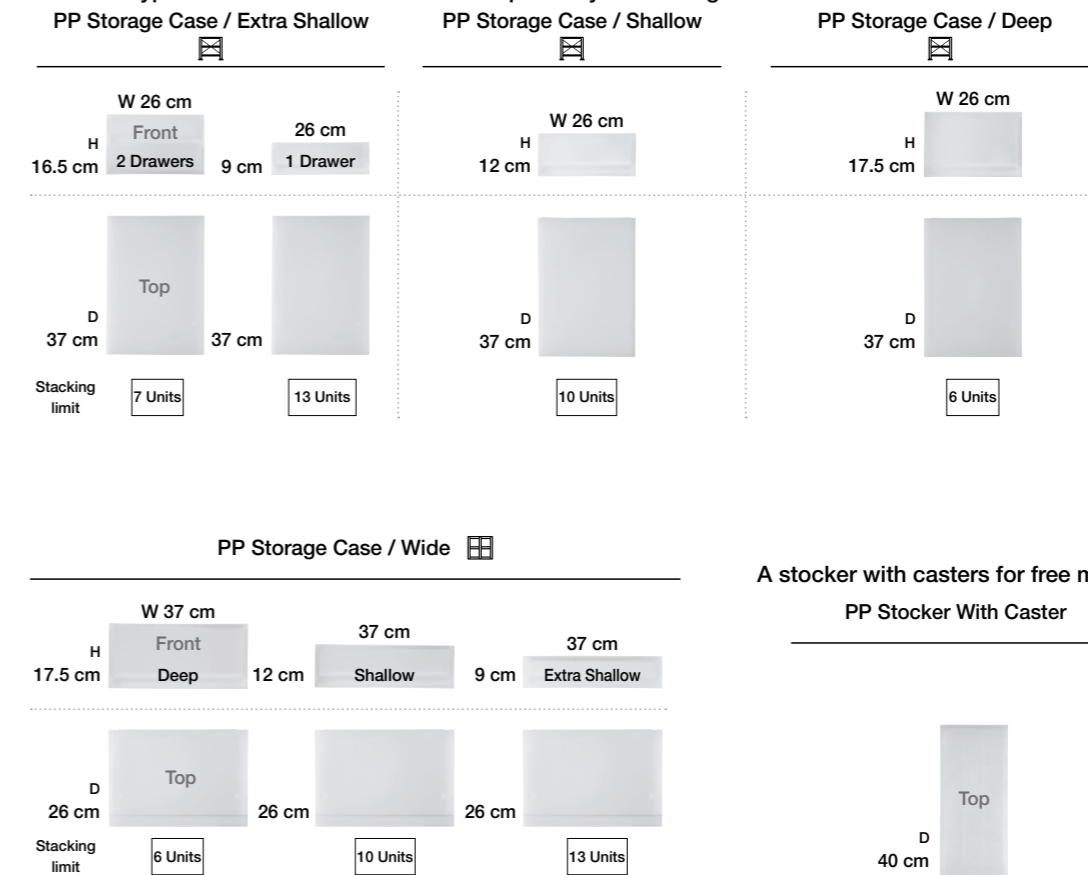

A stocker with casters for free movement.

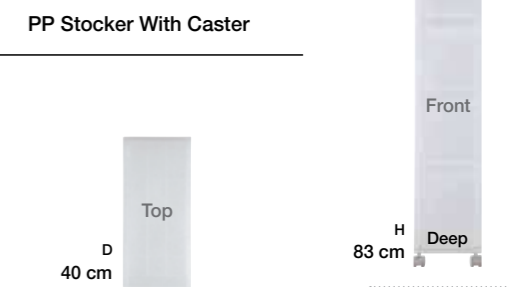

* To ensure safety, please follow the stacking limit and withstand load requirements.
* The polypropylene cases have slight differences in size due to the characteristics of material. When stacked, each case may differ slightly in height.



PP Storage Case / Extra Shallow / White Grey

4550002108281
5.50 KD, 65.00 SAR/AED/QR,
6.5 BD/OMR
Approx. W 26 × D 37 × H 9 cm



PP Storage Case / Shallow / 2 Drawers / White Grey

4550002108304
7.50 KD, 95.00 SAR/AED/QR,
10.00 BD/OMR
Approx. W 26 × D 37 × H 12 cm



PP Storage Case Drawer / S

4547315199686
7.00 KD, 85.00 SAR/AED,
80.00 QR, 8.5 BD/OMR
Approx. W 34 × D 44.5 × H 18 cm



PP Storage Case Drawer / L

4547315527021
8.50 KD, 100.00 SAR/AED,
95.00 QR, 10.00 BD/OMR
Approx. W 34 × D 44.5 × H 24 cm



PP Storage Case Drawer / D

4547315237005
9.50 KD, 125.00 SAR/AED,
115.00 QR, 12.00 BD/OMR
Approx. W 34 × D 44.5 × H 30 cm



PP Storage Case / Wide / Extra Shallow / 2 Drawers

4550002108335
5.50 KD, 65.00 SAR/AED/QR,
6.5 BD/OMR
Approx. W 37 × D 26 × H 9 cm



PP Storage Case / Wide / Extra Shallow / 2 Drawers

4550002118990
7.50 KD, 95.00 SAR/AED/QR,
10.00 BD/OMR
Approx. W 37 × D 26 × H 9 cm



PP Storage Case / Wide / Shallow / White Grey

4550002108328
6.50 KD, 80.00 SAR/AED/QR,
7.5 BD/OMR
Approx. W 37 × D 26 × H 12 cm



PP Storage Case Drawer / Wide / S

4945247266733
9.50 KD, 125.00 SAR/AED,
115.00 QR, 12.00 BD/OMR
Approx. W 55 × D 44.5 × H 18 cm



PP Storage Case Drawer / Wide / L

4945247266740
12.50 KD, 145.00 SAR/AED,
135.00 QR, 16.00 BD/OMR
Approx. W 55 × D 44.5 × H 24 cm



Pp Storage Case Drawer / Wide Deep

4548718182800
14.00 KD, 170.00 SAR/AED,
160.00 QR, 17.00 BD/OMR
Approx. W 55 × D 44.5 × H 30 cm



PP Storage Case / Wide / Deep / White Grey

4550002108311
9.00 KD, 115.00 SAR/AED/QR,
11.00 BD/OMR
Approx. W 37 × D 26 × H 17.5 cm



PP Storage Case Drawer / Wide / M / 3 Row

4548718510252
27.00 KD, 335.00 SAR/AED, 315.00
QR, 30.00 BD/OMR
Approx. W 55 × D 44.5 ×
H 67.5 cm



PP Storage Case Drawer / Wide / M / 4 Row

4548718510269
30.00 KD, 370.00 SAR/AED,
350.00 QR, 40.00 BD/OMR
Approx. W 55 × D 44.5 × H 90 cm



Polypropylene Storage Case / Extra Shallow (Approx. W 26 × D 37 cm)



PP Storage Case / Extra Shallow

4548076749073 | 2 Drawers
8.00 KD, 90.00 SAR/AED, 85.00 QR,
9.00 BD/OMR

Approx. W 26 × D 37 × H 16.5 cm
Stacking limit: 7 units



4548076749066 | 1 Drawer
5.50 KD, 65.00 SAR/AED, 60.00 QR,
6.5 BD/OMR

Approx. W 26 × D 37 × H 9 cm
Stacking limit: 13 units

Inside dimensions (all items):
Approx. W 22.5 × D 34 × H 5.5 cm

Withstand load (all items) (with/without
casters):
Approx. 2 kg per drawer, approx. 2 kg on top
board

Polypropylene Storage Case Drawer/Deep (Approx. W 26 × D 37 cm)



PP Storage Case Drawer / Deep

4548076749011 | 1 Drawer
6.50 KD, 80.00 SAR/AED, 75.00 QR,
7.5 BD/OMR

Approx. W 26 × D 37 × H 17.5 cm



4547315253586 | 1 Drawers
6.50 KD, 80.00 SAR/AED/QR, 7.5 BD/OMR

Approx. W 14 × D 37 × H 17.5 cm

Polypropylene Storage Case / Deep (Approx. W 26 × D 37 cm)



PP Storage Case Drawer / Deep / Partition

4548076749028 | 2 Drawers (with partition)
10.00 KD, 125.00 SAR/AED, 115.00 QR,
12.00 BD/OMR

Approx. W 26 × D 37 × H 17.5 cm

Inside dimensions: Approx. W 10.5 × D 33.5 ×
H 14 cm

Withstand load (with/without casters): Approx. 2
kg per drawer, approx. 2 kg on top board

4 partitions (movable in 4 steps per drawer in
increments of approx. 6 cm)



PP Storage Case Drawer / Deep / Half

4548076749035 | 1 Drawer
5.50 KD, 70.00 SAR/AED, 65.00 QR,
7.00 BD/OMR

Approx. W 14 × D 37 × H 17.5 cm

Polypropylene Storage Case / Wide



PP Storage Case / Wide / Extra Shallow

4547315253753

5.50 KD, 65.00 SAR/AED, 60.00 QR,
6.5 BD/OMR

W 37 × D 26 × H 9 cm

Inside dimensions:

Approx. W 34 × D 22.5 × H 5.5 cm

Withstand load (with/without casters):

Approx. 1 kg per drawer, approx. 5 kg on top
board (with reinforcement bar)

Stacking limit: 13 units



4547315253777 | 2 Drawers

7.00 KD, 85.00 SAR/AED, 80.00 QR,
9.00 BD/OMR

W 37 × D 26 × H 9 cm

Inside dimensions:

Approx. W 16.5 × D 22.5 × H 5.5 cm

Withstand load (with/without casters):

Approx. 0.5 kg per drawer, approx. 5 kg on
top board (with reinforcement bar)

Stacking limit: 13 units



PP Storage Case / Wide

4547315253784 | Shallow

6.50 KD, 80.00 SAR/AED, 75 QR, 8 BD/OMR

W 37 × D 26 × H 12 cm

Inside dimensions:

Approx. W 33.5 × D 22.5 × H 8.5 cm

Withstand load (with/without casters):

Approx. 1.5 kg per drawer, approx. 5 kg on top
board (with reinforcement bar)

Stacking limit: 10 units



4547315253791 | Deep

9.00 KD, 115.00 SAR/AED, 105 QR, 11 BD/
OMR

W 37 × D 26 × H 17.5 cm

Inside dimensions:

Approx. W 33 × D 22.5 × H 14 cm

Withstand load (with/without casters):

Approx. 2 kg per drawer, approx. 5 kg on top board (with
reinforcement bar)

Stacking limit: 6 units



Polypropylene Storage Box / Wide Type (Approx. W 40 x D 65 cm)



PP Storage Clothes Drawer
4547315112081 | D -
**12.00 KD, 140.00 SAR/AED,
130.00 QR, 15.00 BD/OMR**

Approx. W 40 x D 65 x H 30 cm
Inside dimensions:
Approx. W 33 x D 59 x H 24.5 cm
Stacking limit: 6 units



4547315112098 | L -
**9.00 KD, 115.00 SAR/AED,
105.00 QR, 11.00 BD/OMR**

Approx. W 40 x D 65 x H 24 cm
Inside dimensions:
Approx. W 33.5 x D 59 x H 18.5 cm
Stacking limit: 7 units

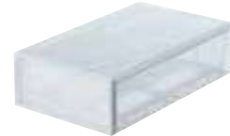

4547315112104 | S -
**7.50 KD, 90.00 SAR/AED, 85.00 QR,
10.00 BD/OMR**

Approx. W 40 x D 65 x H 18 cm
Inside dimensions:
Approx. W 33.5 x D 59.5 x H 12.5 cm
Stacking limit: 8 units
Withstand load (all items):
Approx. 7 kg (with casters:
approx. 3.5 kg)

Polypropylene Storage Box / Wide Type (Approx. W 44 x D 55 cm)



PP Storage Closet Drawer
4547315199693 | D -
**12.00 KD, 140.00 SAR/AED,
130.00 QR, 15.00 BD/OMR**

Approx. W 44 x D 55 x H 30 cm
Inside dimensions:
Approx. W 38 x D 49.5 x H 24.5 cm
Stacking limit: 6 units



4547315199709 | L -
**9.00 KD, 115.00 SAR/AED,
105.00 QR, 11.00 BD/OMR**

Approx. W 44 x D 55 x H 24 cm
Inside dimensions:
Approx. W 38.5 x D 49.5 x H 18.5 cm
Stacking limit: 7 units



4547315236640 | S -
**7.50 KD, 90.00 SAR/AED,
85.00 SAR/AED, 10.00 BD/OMR**

Approx. W 44 x D 55 x H 18 cm
Inside dimensions:
Approx. W 38.5 x D 50 x H 12.5 cm
Stacking limit: 8 units
Withstand load (all items):
Approx. 7 kg (with casters: approx. 3.5 kg)

Polypropylene Storage Case / Drawer / Shallow (Approx. W 26 x D 37 cm)



PP Storage Case Drawer / Shallow
4548076748977 -
**6.00 KD, 75.00 SAR/AED,
70.00 QR, 7.00 BD/OMR**
Approx. W 26 x D 37 x H 12 cm



4547315253579 - **6.00 KD, 75.00 SAR/AED/QR,
7.00 BD/OMR**
Approx. W 55 x D 44.5 x H 24 cm



Pp Storage Case Drawer / Shallow / 3 Row
4548076748991 - **12.00 KD, 140.00 SAR/AED,
130.00 QR, 15.00 BD/OMR**
Approx. W 26 x D 37 x H 32.5 cm



**PP Storage Case Drawer / Shallow /3Row /
Partition**
4548076749004 - **19.00 KD, 245.00 SAR/AED,
230.00 QR, 23.00 BD/OMR**
Approx. W 26 x D 37 x H 32.5 cm



Pp Storage Case Drawer / Shallow / Half
4548076749042 - **5.5.00 KD, 65.00 SAR/AED,
60.00 QR, 6.5 BD/OMR**
Approx. W 14 x D 37 x H 12 cm



Pp Storage Case Drawer / Shallow /Partition
4548076748984 - **7.5.00 KD, 95.00 SAR/AED,
90.00 QR, 10.00 BD/OMR**
Approx. W 26 x D 37 x H 12 cm

Polypropylene Trolley & Additional Drawer



**PP Storage Stoker With Caster 4
Drawer**
4547315521821
**19.00 KD, 245.00 SAR/AED,
230.00 QR, 23.00 BD/OMR**
Approx. W 18 x D 40 x H 83 cm
Inside dimensions:
(Drawer) approx. W 13 x D 35.5 x
H 17 cm



PP Stoker With Caster
4547315880195
**22.00 KD, 270.00 SAR/AED,
255.00 QR, 27.00 BD/OMR**
Approx. W 18 x D 40 x H 83 cm
Inside dimensions:
(Drawer) approx. W 13 x D 35.5 x
H 17 cm
(Deep drawer) approx. W 12.5 x D 35 x
H 26.5 cm
(Shallow drawer) approx. W 13 x D 36 x
H 7 cm



PP Additional Drawer
4547315880171 | Shallow
**5.00 KD, 60.00 SAR/AED,
55.00 QR, 6.5 BD/OMR**
Approx. W 18 x D 40 x H 11 cm
Inside dimensions: Approx. W 13 x D 36 x
H 7 cm
Stacking limit: 10 units

4945247721584
**5.50 KD, 65.00 SAR/AED,
60.00 QR, 7.00 BD/OMR**
Approx. W 18 x D 40 x H 21 cm
Inside dimensions: Approx. W 13 x D 35.5 x
H 17 cm
Stacking limit: 5 units



PP Storage Stoker With Caster 1
4547315880188
**19.00 KD, 245.00 SAR/AED,
230.00 QR, 23.00 BD/OMR**
Approx. W 18 x D 40 x H 83 cm

Inside dimensions:
(Drawer) approx. W 13 x D 35.5 x
H 17 cm



**PP Storage Wagon With Caster
2014**
4547315253807
**12.00 KD, 140.00 SAR/AED,
130.00 QR, 15.00 BD/OMR**
Approx. W 29 x D 41.5 x H 83 cm

4547315880164 | Deep
**7.50 KD, 90.00 SAR/AED, 85.00 QR,
10.00 BD/OMR**
Approx. W 18 x D 40 x H 30.5 cm
Inside dimensions: Approx. W 12.5 x D 35 x
H 26.5 cm
Stacking limit: 4 units

* Remove the top board or casters to add additional drawers and create your own original set.

* Can be stacked up to about 122 cm in height in any combination.



Caster For PP Storage Case

4547315523788 | Set of 4
**3.00 KD, 35.00 SAR/AED,
30.00 QR, 3.00 BD/OMR**

Approx. W 3.5 x D 3.5 x H 6 cm
These casters can be easily attached to the bottom of the following polypropylene cases by inserting the connectors into the holes.

* Using the casters increases the total height by approx. 3.8 to 4.2 cm (exact height-increase depends on the case used).

* Do not use casters on tatami, cushion floors, or other soft flooring in order to prevent damage to the floor.

⚠ Please note the set cannot be disassembled again once it has been put together.



Furniture

Oak & Walnut



Oak

Used for furniture and floorboards for many years, oak which is hard, solid and durable is a perfect material for long-lasting furniture. The delicate and soft expression creates furniture with a mellow impression.

Patterns called "tiger grain" which resemble the pattern of tiger stripes and its delicate and gentle grain are characteristics of oak. The look of oak is enhanced as the material ages over time.



Walnut

Walnut is a well-known wood material that has been used for furniture since olden times and is still used today for high-end furniture and crafts. It features a beautiful surface and little warping.

Ageing of the wood can be enjoyed as the wood contains a moderate amount of oil which provides glossiness and allows the wood to age well. Walnut is treasured as one of the world's three major wood types together with teak and mahogany.



Stacking Shelves

Free to be used horizontally or vertically, stacking shelves are a strong and attractive storage solution. A large number of our storage products will fit into stacking shelves, for the ultimate modular storage solution. Stacking shelves use metal rods inside and are available in both oak and walnut colour.



Basic configuration of stacking shelf

The units can be easily linked by connecting the steel pipes inside the dividers and fastening them with the bolts. MUJI's storage items fit nicely in these shelves. Original storage furniture can be freely created by combining a basic set with additional sets.

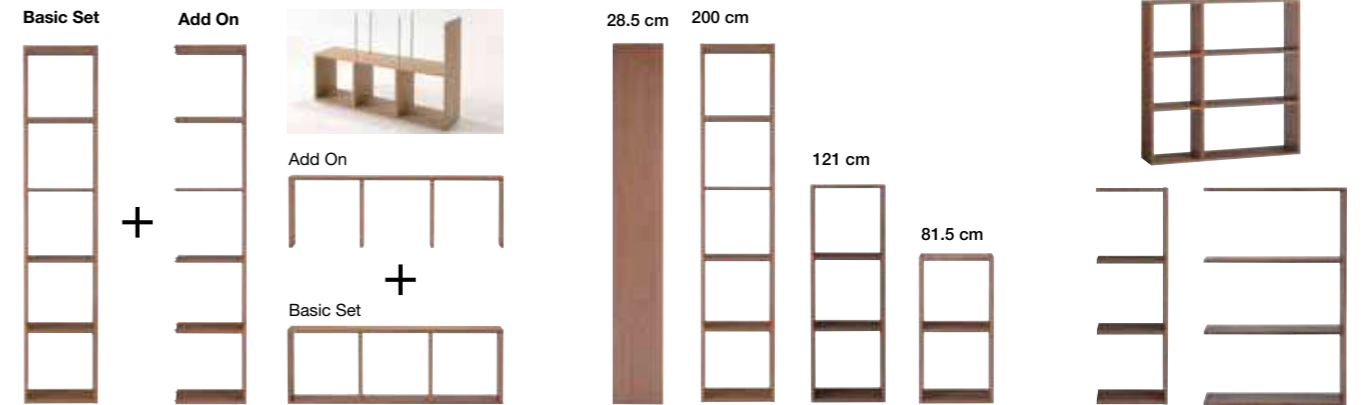

By combining a basic set with additional sets, you can extend the shelves vertically and horizontally to achieve your desired configuration.

This item is only available in depth 28.5 cm. You can choose from three heights.

Example: You can choose from two block widths.

Stacking mechanism

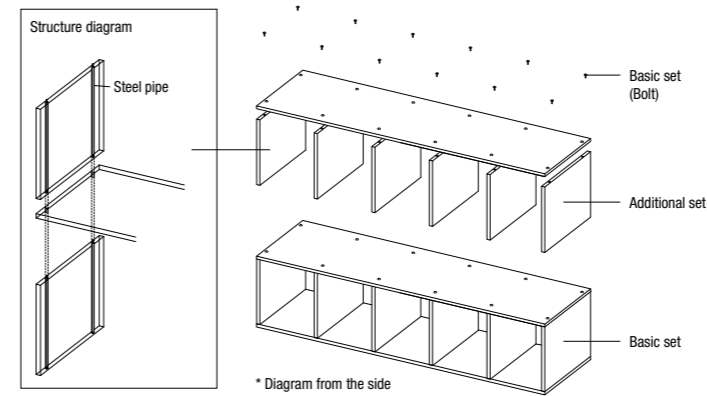

Example of Usage

Combination of differing tiers

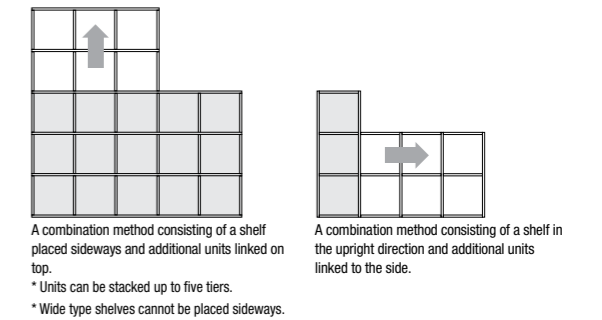

Example of combination and withstand load

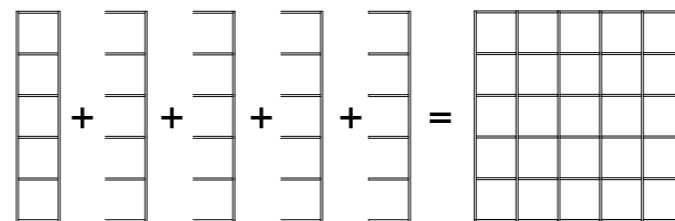

Narrow 5 shelf x 1 + Narrow 5 shelf Add On x 4

A combination method consisting of a shelf in the upright direction and additional units linked to the side.

Withstand load: 150 kg total = 60 kg x 5 units ÷ 2

Total withstand load when shelves are combined = Withstand load of set x number of units ÷ 2

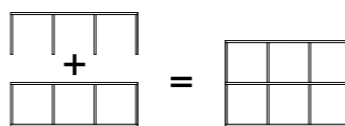

Narrow 3 shelf x 1 + Narrow 3 shelf Add On x 1

A combination method consisting of a shelf placed sideways and additional units linked on top.

Withstand load: 40 kg total = 40 kg x 2 units ÷ 2

Total withstand load when shelves are combined = Withstand load of set x number of units ÷ 2

Combination of items with differing widths

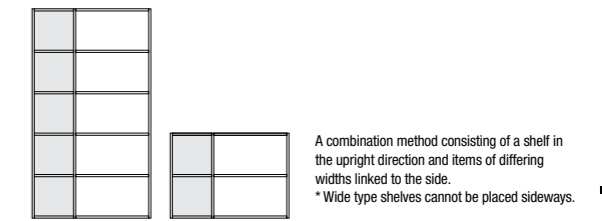

Using as a partition

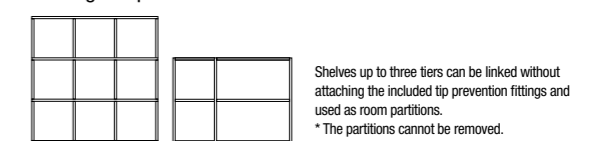

Basic Set The basic set comes in three types: 5 shelf, 3 shelf and 2 shelf, and two widths.

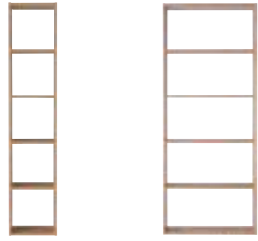

5 Shelf
W 42 x H 200 cm W 81.5 x H 200 cm



3 Shelf
W 42 x H 121 cm W 81.5 x H 121 cm



2 Shelf
W 42 x H 81.5 cm W 81.5 x H 81.5 cm

* Depth for all types is 28.5 cm

Narrow 5 Shelves	Narrow 3 Shelves	Narrow 2 Shelves
105.00 KD, 1,250.00 SAR/AED/QR, 129.00 BD/OMR	85.00 KD, 1,050.00 SAR/AED/QR, 105 BD/OMR	69.00 KD, 950.00 SAR/AED/QR, 85 BD/OMR
4549738932116 Oak - 4549738932314 Walnut	4549738932109 Oak 4549738932307 Walnut	4549738932093 Oak 4549738932291 Walnut
Wide 5 Shelves	Wide 3 Shelves	Wide 2 Shelves
135.00 KD, 1,750.00 SAR/AED/QR, 165.00 BD/OMR	109.00 KD, 1,350.00 SAR/AED/QR, 135.00 BD/OMR	95.00 KD, 1,150.00 SAR/AED/QR, 115.00 BD/OMR
4549738932178 Oak 4549738932376 Walnut	4549738932161 Oak 4549738932369 Walnut	4549738932154 Oak 4549738932352 Walnut

Add On By combining a basic set with additional sets, you can extend the shelves vertically and horizontally.

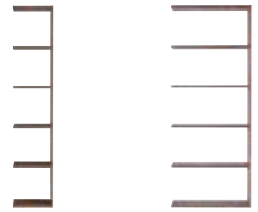

5 Shelf
W 40 x H 200 cm W 79.5 x H 200 cm



3 Shelf
W 40 x H 121 cm W 79.5 x H 121 cm



2 Shelf
W 40 x H 81.5 cm W 79.5 x H 81.5 cm

* Depth for all types is 28.5 cm

Narrow 5 Shelves (Add On)	Narrow 3 Shelves (Add On)	Narrow 2 Shelves (Add On)
95.00 KD, 1,150.00 SAR/AED/QR, 115.00 BD/OMR	79.00 KD, 950.00 SAR/AED/QR, 95.00 BD/OMR	65.00 KD, 850.00 SAR/AED/QR, 79.00 BD/OMR
4549337263208 Oak 4549337265677 Walnut	4549337263192 Oak 4549337265660 Walnut	4549337263185 Oak 4549337265653 Walnut
Wide 5 Shelves (Add On)	Wide 3 Shelves (Add On)	Wide 2 Shelves (Add On)
125.00 KD, 1,550.00 SAR/AED/QR, 155.00 BD/OMR	105.00 KD, 1,250.00 SAR/AED/QR, 125.00 BD/OMR	89.00 KD, 1,050.00 SAR/AED/QR, 110.00 BD/OMR
4549337263260 Oak 4549337265738 Walnut	4549337263253 Oak 4549337265721 Walnut	4549337263246 Oak 4549337265714 Walnut

Optional Parts for Stacking Shelf This item can be used by itself or in combination with a stacking shelf.



1 x 2 Drawer Set
45.00 KD, 550.00 SAR/AED/QR,
55.00 BD/OMR
4550002554057 | Oak
4550002554088 | Walnut
W 37 x D 28 x H 37 cm
Withstand load: Top board 5 kg, each
drawer 3 kg, total 5 kg
Inside dimensions of drawer: W 33.5
x D 24.5 x H 15.5 cm



1 x 4 Drawer Set
45.00 KD, 550.00 SAR/AED/QR,
55.00 BD/OMR
4550002554071 | Oak
4550002554101 | Walnut
W 37 x D 28 x H 37 cm
Withstand load: Top board 5 kg, each
drawer 2 kg, total 5 kg
Inside dimensions of drawer: W 33.5 x
D 24.5 x H 6 cm



2 x 2 Drawer Set
45.00 KD, 550.00 SAR/AED/QR,
55.00 BD/OMR
4550002554064 | Oak
4550002554095 | Walnut
W 37 x D 28 x H 37 cm
Withstand load: Top board 5 kg,
each drawer 2 kg, total 5 kg
Inside dimensions of drawer: W 15
x D 24.5 x H 15.5 cm

* The material used inside the drawers (MDF) may have a distinct smell. Although the smell will fade with use, it is recommended to avoid storing clothing or other items that can absorb odour inside the drawers.



1 x 2 Drawer Set
25.00 KD, 300.00 SAR/AED/QR,
30.00 BD/OMR
4550002528515 | Oak
4550002528522 | Walnut
W 37 x D 28 x H 18.5cm



1 x 2 Drawer Set
25.00 KD, 300.00 SAR/AED/QR,
30.00 BD/OMR
4550002528706 | Oak
4550002528713 | Walnut
W 37 x D 28 x H 18.5cm



Dining

Made with North American natural wood which ages well over time.



Tables:



Natural Oak Table (With Drawer) / W 180 cm

4550182009330 - 289.00 KD, 2,999.00 SAR/AED/QR, 375.00 BD/OMR

W 180 x D 80 x H 72 cm



Natural Oak Table (With Drawer) W 140 cm

4550182009323 - 259.00 KD, 2,699.00 SAR/AED/QR, 335.00 BD/OMR

W 140 x D 80 x H 72 cm



Natural Walnut Table (With Drawer) / W 180 cm

4550182049480 - 289.00 KD, 2,999.00 SAR/AED/QR, 375.00 BD/OMR

W 180 x D 80 x H 72 cm



Natural Walnut Table (With Drawer) / W 140 cm

4550182049473 - 259.00 KD, 2,699.00 SAR/AED/QR, 335.00 BD/OMR

W 140 x D 80 x H 72 cm



Bench / Wooden Seat

4547315892334 | Walnut - 125.00 KD, 1,550.00 SAR/AED, 1500 QR, 155.00 BD/OMR

W 100 x D 37 x H 44 cm

Inside dimensions of storage compartment:

W 91 x D 20 x H 11 cm



Table Bench / Wooden Seat

4547315892419 | Oak - 125.00 KD, 1,550.00 SAR/AED, 1500 QR, 155.00 BD/OMR

W 100 x D 37 x H 44 cm

Inside dimensions of storage compartment:

W 91 x D 20 x H 11 cm



Bench Shelf

4547315892426 | Oak - 160.00 KD, 2,090.00 SAR/AED, 2000.00 QR, 200.00 BD/OMR

W 120 x D 37.5 x H 44 cm

Inside dimensions of storage compartment:

W 115 x D 37.5 x H 33 cm

A good height to use even as a low table and enough strength for use as a bench. The space under the seat can be used as a storage space.



Bench Shelf

4547315967476 | Walnut - 160.00 KD, 2,090.00 SAR/AED, 2000.00 QR, 200.00 BD/OMR

W 120 x D 37.5 x H 44 cm

Inside dimensions of storage compartment:

W 115 x D 37.5 x H 33 cm

A good height to use even as a low table and enough strength for use as a bench. The space under the seat can be used as a storage space.



Table Round Legs / Oval
4547315901999 | Natural Oak
390.00 KD, 4,900.00 SAR/AED,
4950 QR, 480.00 BD/OMR
W 180 × D 80 × H 72 cm



Bench Round Legs
4550002065959 | Oak
150.00 KD, 1,750.00 SAR/AED/QR,
180.00 BD/OMR
W 100 × D 35 × H 44 cm



Stool Round Legs
4550002065966 | Oak
100.00 KD, 1,200.00 SAR/AED/QR,
125.00 BD/OMR
W 55 × D 32 × H 74 cm



Bench / S
4547315892365 | Oak
35.00 KD, 450.00 SAR/AED,
425.00 QR, 43.00 BD/OMR
W 45 × D 30 × H 44 cm



Bench / L
4547315892358 | Oak
40.00 KD, 500.00 SAR/AED,
475.00 QR, 48.00 BD/OMR
W 100 × D 30 × H 44 cm



Oak Desk
4934761361901 | Oak
99.00 KD, 1,850.00 SAR/AED/QR,
170.00 BD/OMR
W 110 × D 52 × H 70 cm
Laminated natural oak
Design considers placement of
cables when using a computer.
The holder can be attached on the
right, left side or in the centre of
the rear beam.



Cabinet
4934761361925 |
Oak
69.00 KD,
1,350.00 SAR/
AED/QR, 125.00
BD/OMR
W 37.5 × D 40.5
× H 58.5 cm



Chair

We have prepared chairs made of different materials and types of comfort to match a variety of tables.



Round Chair
4550182009255 | Oak
65.00 KD, 750.00 SAR/AED/QR,
65.00 BD/OMR
W 45 × D 51 × H 77 (seat surface: 42) cm

This chair was created with a focus on comfort. The rounded back and seat will fit comfortably around the body. The back rest is made wide and tall and is curved to allow the body to fit in. The seat is also wide and curved, realising a comfortable fit.



Arm Chair Round Legs
4547315902040 | Oak
165.00 KD, 2,000.00 SAR/AED/QR,
205.00 BD/OMR
W 55 × D 32 × H 74 (seat surface: 42) cm



Walnut Chair
4547315967469 | Cotton Plain Weave / Beige
Main body: Walnut
52.00 KD, 690.00 SAR/AED,
650.00 QR, 65.00 BD/OMR
W 38 × D 48.5 × H 79 (seat surface: 45.5) cm



Oak Chair
4547315892372 | Cotton Plain Weave / Beige
Main body: laminated natural oak
52.00 KD, 690.00 SAR/AED,
650.00 QR, 65.00 BD/OMR
W 38 × D 48.5 × H 79 (seat surface: 45.5) cm



The timeless basic design is ideal for desks.

You can add components and modify usage to suit your child's growth and development. One of the charms of natural wood is that it changes colour with age. You can create functional, compact and easy-to-clean desk spaces by combining the desk with storage furniture of the same material.

Living Room



Sofa

A sofa in a simple shape.
Parts can be replaced which enables use over many years.



Sofa / Urethane / Pocket Coil / Left

4550182011449 | 3 seater + 8 Legs / H 10 cm
330.00 KD/BD/OMR, 4,000.00 SAR/AED/QR
W 225.5 x D 150 x H 80 cm (with Legs/H 10 cm attached)



Sofa / Urethane / Pocket Coil / Right

4550182011456 | 3 seater + 8 Legs / H 10 cm
330.00 KD/BD/OMR, 4,000.00 SAR/AED/QR
W 225.5 x D 150 x H 80 cm (with Legs/H 10 cm attached)



SOFA / FEATHER / POCKET COIL / OTTOMAN / L

4550182008098 | + Legs / H 10 cm
65.00 KD/BD/OMR, 750.00 SAR/AED/QR
W 77 x D 54.5 x H 40 cm (with Legs/H 10 cm attached)



SOFA / WIDE ARM / FEATHER / POCKET COIL

4550182011425 | 3 seater + 8 Legs / H 10 cm
270.00 KD/BD/OMR, 3,250.00 SAR/AED/QR
W 225.5 x D 88 x H 80 cm (with Legs/H 10 cm attached)

Common leg types



Wooden Leg

4550002528867 / Natural
10.00 KD, 100.00 SAR/AED/QR, 14.00 BD/OMR
H 10 cm
M8 dia. 6 cm / set of 4

Main unit		Cover	
		Plain Weave Cotton	Beige
Sofa cover / 3S 125.00 KD, 1,500.00 SAR/AED/QR, 155.00 BD/OMR Ottoman: 32.00 KD/BD/OMR, 400.00 SAR/AED/QR	Type Left	Cotton Polyester	4550182074338
	Type Right	Cotton Polyester	4550182074321
	Wide Arm	Cotton Polyester	4550182074239
	Ottoman	Cotton Polyester	4550182074307



Unit Sofa

Sofa modules that can be mixed and matched to fit your lifestyle.



Unit Sofa / Armless / L

4550002527990

150.00 KD, 1,800.00 SAR/AED/QR,
195.00 BD/OMR

W 77 × D 98 × H 66 cm



Unit Sofa / With Arms / L

4550002527983

180.00 KD, 2,200.00 SAR/AED/QR,
235.00 BD/OMR

W 98 × D 98 × H 66 cm



Unit Sofa / Ottoman / L

4550002528003

89.00 KD, 1,100.00 SAR/AED/QR,
120.00 BD/OMR

W 77 × D 77 × H 37 cm



Unit Sofa Cushion

4549738666349

13.00 KD, 150.00 SAR/AED/QR, 17.00 BD/OMR

W 61 × D 16 × H 13 cm



Unit Sofa cover chart

		Cover	Plain Weave Cotton	
			Beige	Dark Brown
Main unit				
13.00 KD, 150.00 SAR/AED/QR 17.00 BD/OMR	Cushion	Cotton Polyester	4550002884932 W 77 cm	4550002884949 W 77 cm
40.00 KD, 500.00 SAR/AED/QR, 54.00 BD/OMR	Armless	Cotton Polyester	4550002884895 W 77 cm	4550002884901 W 77 cm
65.00 KD, 800.00 SAR/AED/QR, 85.00 BD/OMR	With Armset	Cotton Polyester	4550002884871 W 98 cm	4550002884888 W 98 cm
25.00 KD, 300.00 SAR/AED/QR, 33.00 BD/OMR	Ottoman	Cotton Polyester	4550002884918 W 77 cm	4550002884925 W 77 cm

These sofas are carefully designed for seating comfort and can be freely combined into a variety of configurations.

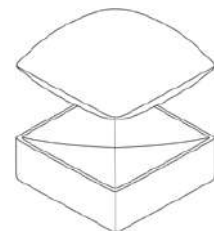

The seat cushions are constructed from a concave moulded urethane base topped with a bag filled with crushed urethane foam, for plush seating comfort.

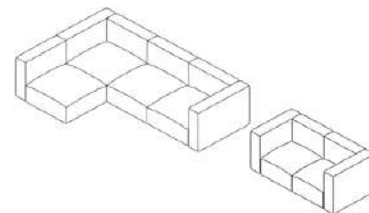

The units can be combined to create a sofa set for a large living room, or they can be used individually as a compact sofa. You can freely select the combination that best suits your lifestyle and living space.

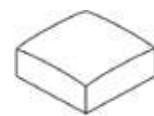
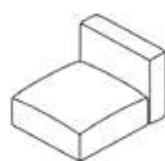
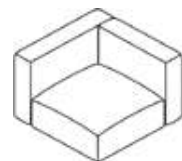

Whether your preference is to use a single module as a roomy seat for one person, or combine multiple modules to use as a complete sofa, you can select a combination that fits your living environment.



Beads Sofa

The beads sofa changes its shape freely to fit your leisure position. Filled with micro particle beads, the sofa wraps around you for comfortable sitting. You can enjoy different seating comfort depending on how the sofa is placed.



Beads Sofa

4934761049182

60.00 KD, 750.00 SAR/AED/QR, 70.00 BD/OMR

W 65 x D 65 x H 43 cm



The micro particle beads maintain its shape and create an extremely soft feel.

Cover for Beads Sofa

15.00 KD, 200.00 SAR/AED/QR, 19.00 BD/OMR

1- 4549337287594 - Charcoal Grey

4- 4548076580294 - Navy

2- 4550002527907 - Heather Grey

5- 4549337100619 - Navy Denim

3- 4934761048888 - Beige

6- 4934761048871 - Dark Brown

Sitting on a "vertically placed" sofa

The sofa wraps around the lower back and neck to support any posture that one wishes to relax in. Perfect when reading or watching TV.

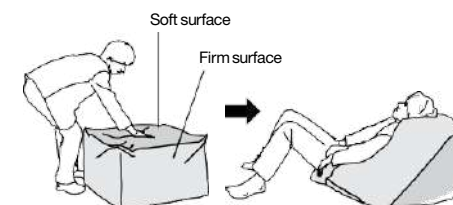

Sitting on a "horizontally placed" sofa

The sofa spreads in a circular manner to allow the body to sink in deeply and be supported. Perfect for taking a nap.

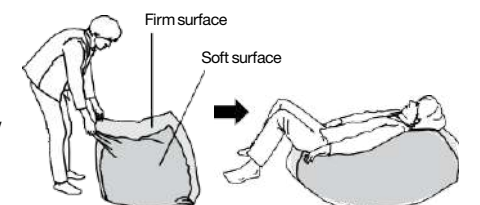

-During the course of use, the beads may settle and cause a slight variance in thickness.

-The Beads Sofa cannot be washed.

-Slight shrinking of the cover may occur by dry cleaning.

-The sofa cannot be used alone. Be sure to use it with a cover.

Floor Chair

This simple floor chair matches any kind of room.
A legless chair with covering. With 6-step reclining function.



Floor Chair (body)
4548718481286 | L
21.00 KD, 300.00 SAR/AED/QR, 27.00 BD/OMR
W 57 x D 102 x H 10 cm

Cotton Canvas Cover For Floor Chair

12.00 KD, 100.00 SAR/AED, 75.00 QR, 14.00 BD/OMR

4549337746886 - Ecu
100% cotton



4547315999699 - Dark Brown
100% cotton



4547315999057 - Beige
100% cotton [Dry cleaning only]*

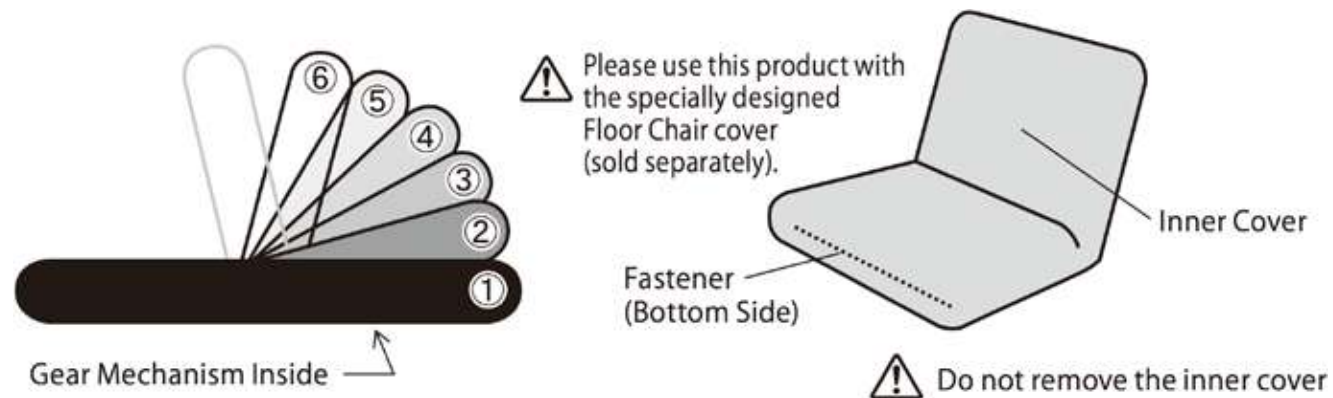

High Back Reclining Sofa

Relax in MUJI's High Back Reclining Sofa. It comes with an adjustable headrest that can be adjusted manually to 6 levels (including flat level).
With optimum durability and comfort from top to bottom, the wooden legs now come in Oak Wood and rounded edges.



High Back Reclining Sofa
4550002405236 | 1S
139.00 KD, 1,749.00 SAR/AED/QR,
180.00 BD/OMR
W 98 x D 98 x H 66 cm

Ottoman
4550002405113
50.00 KD, 650.00 SAR/AED/QR,
70.00 BD/OMR
W 98 x D 98 x H 66 cm



Sofa cover chart

			Cover	
			Beige	Brown
Main unit	Sofa	Cotton Polyester	4550002884512	4550002884529
	Ottoman	Cotton Polyester	4550002884536	4550002884543
60.00 KD, 850.00 SAR/AED/QR, 75.00 BD/OMR				
12.00 KD, 150.00 SAR/AED/QR, 15.00 BD/OMR				



Bedroom

Beds, mattresses, pillows & duvets.



Wooden Beds

Find your ideal bed with a range of styles that are designed to be practical, comfortable, and elegant.

Your original bed frame

MUJI's bed frame was born from feedback from customers seeking an infinite variety of characteristics in beds. By combining the frame with the optional components such as legs, headboard, mattress and underbed storage, you can customise the bed to suit your living style and your desired sleeping comfort.

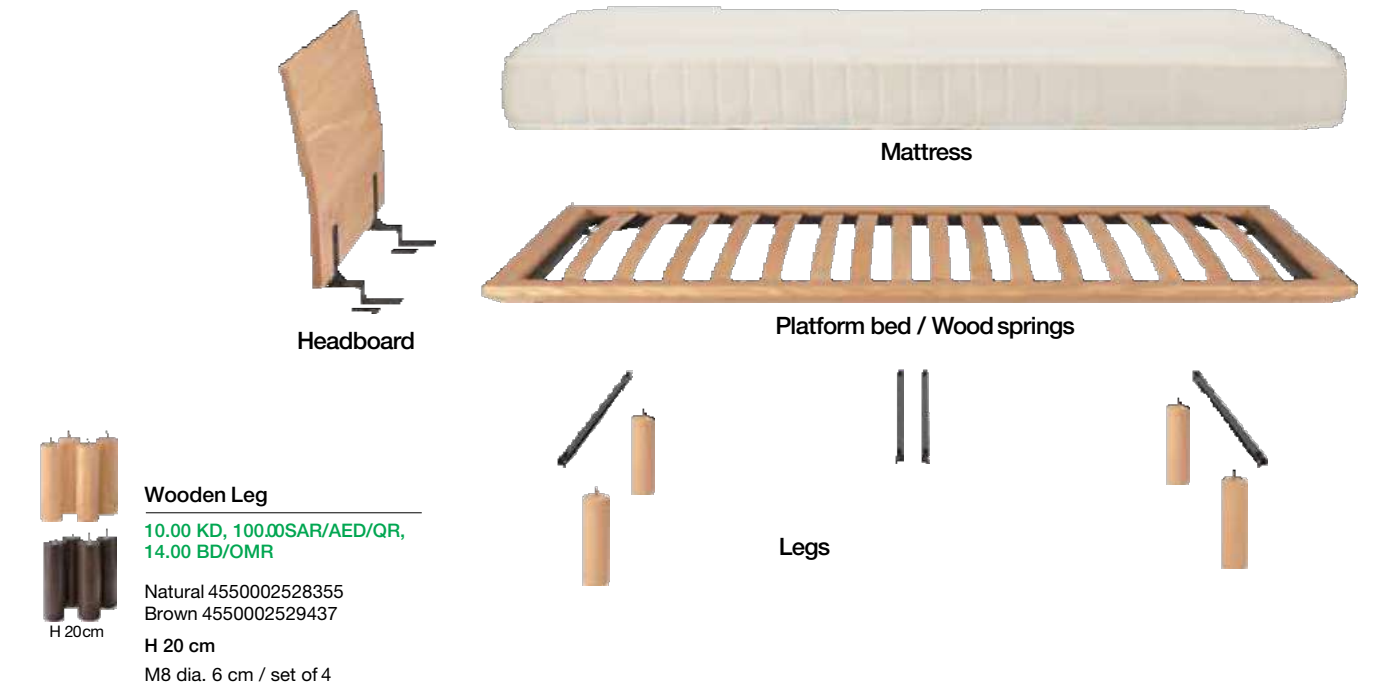

* Example combination: mattress is sold separately.

Bed Frame / Headboard / Oak

4550002850647 | Double W 147 × D 8 × H 53 cm
 75.00 KD, 1,000.00 SAR/AED, 950.00 QR, 95.00 BD/OMR
 4550002855468 | Queen W 171 × D 8 × H 53 cm

4550002855444 | King W 182 × D 8 × H 53 cm
 90.00 KD, 1,200.00 SAR/AED, 1,100 QR, 110.00 BD/OMR



Bed Frame / Main Unit / Oak

4550002527853 | Double -
 175.00 KD, 2,300 SAR/AED, 2,200.00 QR, 221.00 BD/OMR
 4550002527877 | King -
 215.00 KD, 2,600 SAR/AED, 2,550.00 QR, 276.00 BD/OMR
 4550002527860 | Queen -



* Example combination: mattress is sold separately.

Bed Frame / Headboard / Walnut

4550002850685 | Double W 147 × D 8 × H 53 cm
 75.00 KD, 1,000.00 SAR/AED, 950.00 QR, 95.00 BD/OMR
 4550002855475 | Queen W 171 × D 8 × H 53 cm

4550002855451 | King W 182 × D 8 × H 53 cm
 90.00 KD, 1,200.00 SAR/AED, 1,100 QR, 110.00 BD/OMR



Bed Frame / Main Unit / Walnut

4550002528973 | Double -
 175.00 KD, 2,300.00 SAR/AED, 2,200.00 QR, 221.00 BD/OMR
 4550002528997 | King -
 215.00 KD, 2,600 SAR/AED, 2,550.00 QR, 276.00 BD/OMR
 4550002528980 | Queen -

Storage Bed

This single bed features a storage space equal to that of two wide 4-drawer chests. Store everything from daily-use clothing to suitcases and comforters.



Example storage

Example storage under a Double bed



Open space

A storage space is also provided behind the drawer space. In the space under Double size, you can store long or large objects, such as rugs, skis, duvets, and carry cases.
* Bottom board is not provided under the open space.



Ventilation holes are made below the open space to allow moisture to escape.

Drawers

In the drawers, available for all sizes of beds, you can store daily-use clothing and beddings.



Bed board is made of wood slats that reduce the dust getting into the storage compartment.



* Example combination: mattress is sold separately.

Storage Bed Headboard / Oak

4549337497863 | Double
75.00 KD, 1,000.00 SAR/AED, 950.00 QR, 95.00 BD/OMR
4549738371304 | Queen
80.00 KD, 1,100.00 SAR/AED, 1,000.00 QR, 100.00 BD/OMR
4549738371311 | King
90.00 KD, 1,200.00 SAR/AED, 1,100.00 QR, 110.00 BD/OMR



* Example combination: mattress is sold separately.

Storage Bed Headboard / Walnut

4549337497900 | Double
75.00 KD, 1,000.00 SAR/AED, 950.00 QR, 95.00 BD/OMR
4549738371328 | Queen
80.00 KD, 1,100.00 SAR/AED, 1,000.00 QR, 100.00 BD/OMR
4549738371335 | King
90.00 KD, 1,200.00 SAR/AED, 1,100.00 QR, 110.00 BD/OMR

Mattress

Independent barrel-shaped springs have been individually wrapped with non-woven fabric so that each coil moves separately to enable the best hardness for sleeping position..

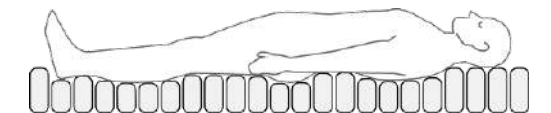
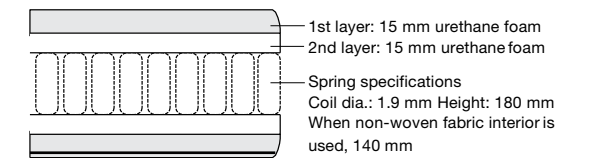

Pocketcoil Spring Mattress

4548718094868 | Double W 140 x D 195 x t 19 cm
250.00 KD, 3,250.00 SAR/AED/QR, 325.00 BD/OMR
4934761863351 | Queen W 160 x D 195 x t 19 cm
300.00 KD, 3,950.00 SAR/AED/QR, 395.00 BD/OMR
4934761854182 | King W 180 x D 195 x t 19 cm
350.00 KD, 4,550.00 SAR/AED/QR, 465.00 BD/OMR



* Example combination: mattress is sold separately.

Storage Bed / Oak

4549337407961 | Double W 147 x D 201 x H 27 cm
185.00 KD, 2,400.00 SAR/AED, 2,300.00 QR, 235.00 BD/OMR
4549738371229 | Queen W 168.5 x D 201 x H 27 cm
210.00 KD, 2,550.00 SAR/AED, 2,500.00 QR, 250.00 BD/OMR
4549738371236 | King W 188.5 x D 201 x H 27 cm
225.00 KD, 2,700.00 SAR/AED, 2,650.00 QR, 290.00 BD/OMR



* Example combination: mattress is sold separately.

Storage Bed / Walnut

4549337408005 | Double W 147 x D 201 x H 27 cm
185.00 KD, 2,400.00 SAR/AED, 2,300.00 QR, 235.00 BD/OMR
4549738371243 | Queen W 168.5 x D 201 x H 27 cm
210.00 KD, 2,550.00 SAR/AED, 2,500.00 QR, 250.00 BD/OMR
4549738371250 | King W 188.5 x D 201 x H 27 cm
225.00 KD, 2,700.00 SAR/AED, 2,650.00 QR, 290.00 BD/OMR

* Due to the nature of the material, oak may have a unique pattern called "tiger grain."
* The characteristics of natural wood, such as the colour and grain pattern, may vary in appearance depending on the material.

Pillow

The "pillow" is an essential part of sleep that accounts for one third of each day. Choose a pillow to your liking from different materials, firmness, and elasticity.



Feather Pillow

4549738756200 | 43 × 63 cm
6.00KD ,70.00 AED/SAR/QR , 8.00 BD/OMR

4549738756217 | 50 × 70 cm
7.50KD ,95.00 AED/SAR, 80.00 QR, 9.500 BD/OMR

Outer shell: 100% cotton, down-proofed finish. Inner shell: 100% polyester
Filling: 100% waterfowl feathers. [Dry-cleaning only (using a petroleum-based detergent)]

This pillow uses waterfowl feathers which are light and maintain volume. This pillow is characterised by the comfort of a soft enveloping feel around the back of the head.



Polyester Pillow

4550002832155 | 43 × 63 cm
10.00KD ,120.00 AED/SAR/QR , 14.00 BD/OMR

Outer shell: 65% polyester, 35% cotton Stuffing: 100% polyester [Non-washable]

This item uses hollow polyester wadding for the stuffing, which has a light and soft feel. It is fluffy and comfortable to use.



Urethane Foam Low Repulsion Chip Pillow

4549337750364 | 43 × 63 cm
8.00KD ,100.00 AED/SAR/QR , 22.00 BD/OMR

Outer shell: 57% polyester, 43% cotton
Stuffing: Urethane foam [Non-washable]

Slow-sinking low-rebounding urethane has been mixed at a perfect blend with high-rebounding urethane having moderate elasticity.



Down Blend Pillow

4549738994411 | 43 × 63 cm
25.00KD ,320.00 AED/SAR, 300.00 QR, 30 BD/OMR

4549738994428 | 50 × 70 cm
30.00KD ,420.00 AED/SAR , 400.00 QR, 35 BD/OMR

Duvet

Duvets designed with consideration of materials and functionality for a comfortable sleep.



Gray Down Duvet One Layer

4550182049589 | 190 × 210 cm
cm 99.00KD ,1250.00 AED/SAR/QR, 120 BD/QMR

4550182049602 | 230 × 210 cm
119.00KD ,1500.00 AED/SAR/QR,140 BD/OMR

4550182049596 | 210 × 210 cm
139.00KD ,1750.00 AED/SAR/QR, 160 BD/OMR

Outer shell: 100% polyester, down-proofed finish

Filling: 80% down, 20% feather

Fill power: 350

Using free ranged, humanely raised gray duck feathers, we have created this lightweight and compact duvet.



Difference between down and feathers



Down

Light, soft, and heat retaining feathers which look like the fluff of a dandelion mostly found around the chest and stomach of waterfowls.



Feather

The portion which is commonly referred to as a feather which has a curved shaft and elasticity.



Natural grey colour

Many grey geese are found in quiet rural areas of Ukraine. Though domesticated long ago, the grey goose retains the dark colour reminiscent of wild migratory geese. The birds roam freely in a natural environment. When fully grown, the grey goose is bigger than a duck and has excellent mobility. The warm and strong feathers of the grey goose are ideal for duvets.



The geese on the farm are fed corn in the morning and after that, they eat naturally growing grass and insects.



Families of geese congregate on nearby lakes and rivers in early spring.



The geese return to the farm in the evening.

Tableware



Acacia

MUJI Acacia serving ware is made in the Philippines. Acacia trees grow more than 50cm in diameter; so just one single tree yields a huge amount of wood. Hollowing out the tree takes a great deal of skill and is carried out by expert local craftspeople.

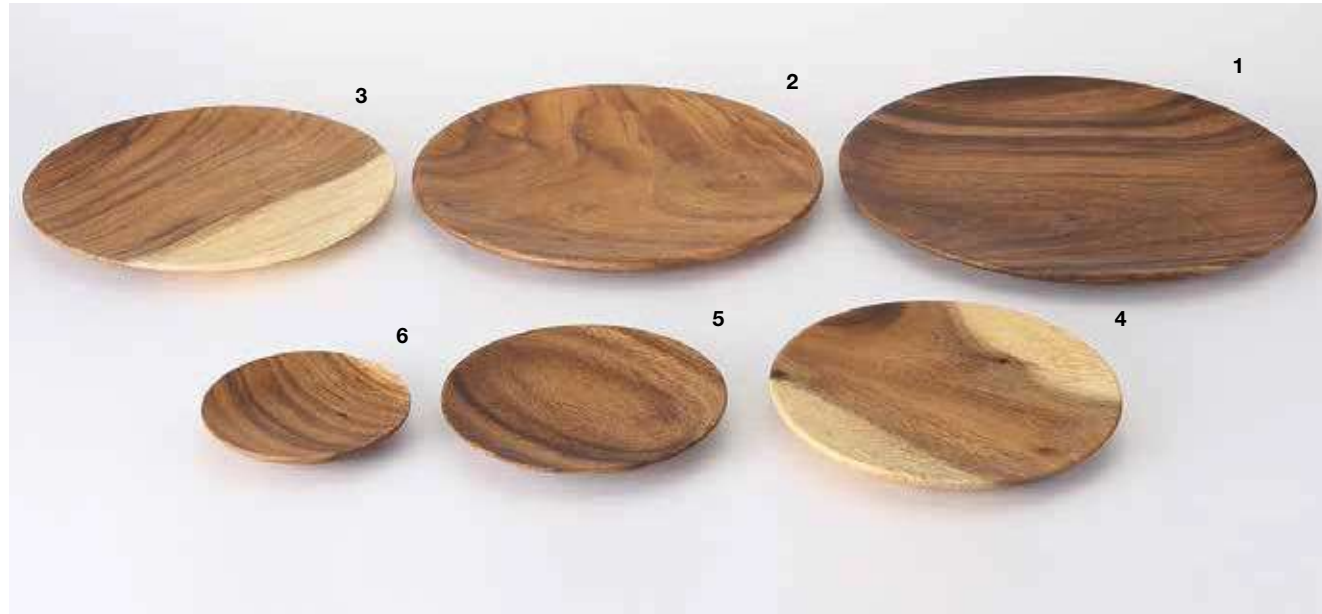

Acacia Plate

1-4549337083578 7.50KD , 80.00 AED/SAR 75.00 QR ,9.50 BD/OMR	Approx.dia. 30 × H 2.5 cm	3-4549337083585 6.5.00KD , 75.00 AED/SAR 70.00 QR ,8.00 BD/OMR	Approx.dia. 23 × H 2 cm	5-4549337083677 3.50KD , 40.00 AED/SAR 35.00 QR ,4.00 BD/OMR	Approx.dia. 15 × H 2 cm
2- 4549337185272 7.00KD , 85.00 AED/SAR 80.00 QR, 8.50 BD/OMR	Approx.dia. 26 × H 2 cm	4-4549337083660 4.50KD , 55.00 AED/SAR 50.00 QR ,6.00 BD/OMR	Approx.dia. 19 × H 2 cm	6-4549337083684 2.00KD , 30.00 AED/SAR 25.00 QR ,3.00 BD/OMR	Approx.dia. 11 × H 2 cm

Acacia Tray

1-4550002882907	Approx.dia. 32 cm	8.00KD ,90.00 AED/SAR/QR 9.00 BD/OMR
2- 4550002882914	Approx.dia. 26cm	6.50KD ,80.00 AED/SAR/QR 8.50 BD/OMR



Acacia Trivet

1-4550002882921	Approx.dia. 20 cm	3.75KD ,45.00 AED/SAR/QR , 5.00BD/OMR
-----------------	-------------------	---------------------------------------



Acacia Bowl

1-4549337082724 21.00KD , 255.00 AED/SAR 250 QR, 27.00 BD/OMR	Approx.dia. 30 × H 10 cm	4-4549337083264 6.00KD , 70.00 AED/SAR 65 QR, 8.00 BD/OMR	Approx.dia. 16 × H 7 cm	6-4549337083288 3.5.00KD , 40.00 AED/SAR 35 QR, 4.00 BD/OMR	Approx.dia. 10 × H 5 cm
2-4549337082731 11.00KD , 115.00 AED/SAR 110 QR, 14.00 BD/OMR	Approx.dia. 24 × H 9 cm	5-4549337083271 4.00KD , 50.00 AED/SAR 45 QR, 5.00 BD/OMR	Approx.dia. 13 × H 6 cm	7-4549337083325 2.00KD , 20.00 AED/SAR 15 QR, 2.50 BD/OMR	Approx.dia. 8 × H 4.5 cm
3-4549337082748 8.00KD , 90.00 AED/SAR 85 QR, 10.00 BD/OMR	Approx.dia. 20 × H 9 cm				

Acacia Deeper Plate

1-4549337083332	Approx.dia. 24 × H 5 cm	7.00KD ,85.00 AED/SAR, 80 QR, 9.00 BD/OMR
2-4549337083349	Approx.dia. 20 × H 4 cm	5.5.00KD ,65.00 AED/SAR, 60 QR, 7.00 BD/OMR
3-4549337083561	Approx.dia. 16 × H 3.5 cm	5.00KD ,55.00 AED/SAR, 50 QR, 6.00 BD/OMR

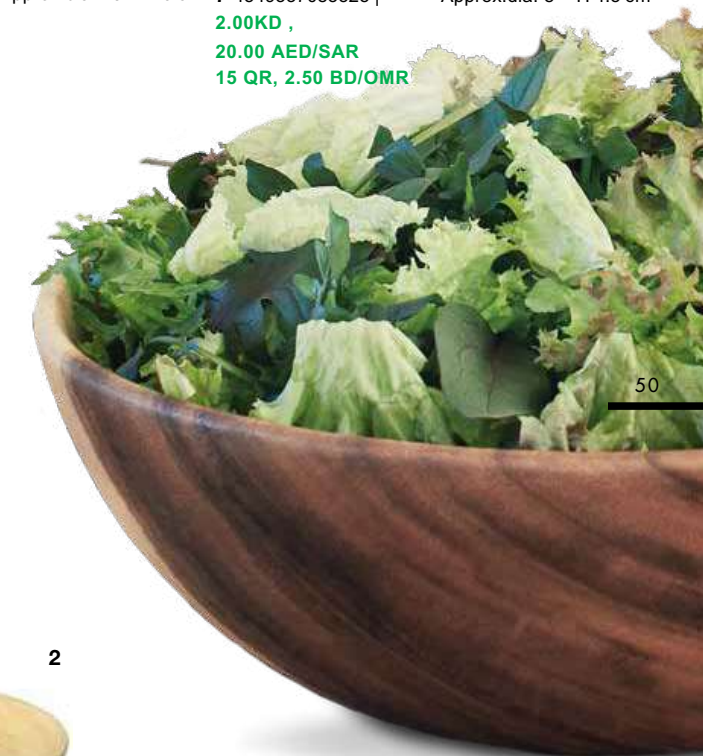

Porcelain

MUJI porcelain is produced in Hasami, a region with long tradition of white porcelain craftsmanship, it's made with highly translucent Amakusa pottery stone.

Beige Porcelain:



Porcelain Beige Deep Dish

L -4547315254514 Approx.dia. 23.5 × H 5 cm 2.00KD ,30.00 AED/SAR/QR, 2.50 BD/OMR	M -4547315254507 Approx.dia. 19 × H 4.5 cm 1.75KD ,25.00 AED/SAR/QR, 2.25 BD/OMR	S - 4547315254491 Approx.dia. 15 × H 3.5 cm 1.25KD ,20.00 AED/SAR/QR, 1.50 BD/OMR
---	---	--

Beige Bowl

L - 4934761488400 Approx.dia. 16.5 cm 3.00KD ,40.00 AED/SAR /QR, 3.75 BD/OMR
M - 4934761488417 Approx.dia. 12.5 cm 2.00KD ,30.00 AED/SAR /QR, 2.50 BD/OMR
S - 4934761488424 Approx.dia. 11.5 cm 1.75KD ,25.00 AED/SAR /QR, 2.25 BD/OMR



Porcelain Beige Stacking Bowl

L -4547315254552 Approx.dia. 12 × H 5.5 cm 2.00KD ,25.00 AED/SAR/QR, 2.50 BD/OMR	M -4547315254545 Approx.dia. 10.5 × H 4.5 cm 1.75 KD , 20.00 AED/SAR/QR, 2.25 BD/OMR	S - 4547315254538 Approx.dia. 9 × H 4 cm 1.50KD ,15.00 AED/SAR/QR, 2.00 BD/OMR
---	---	---

Beige Plate

1 -4945247614220 Approx.dia. 26 cm 3.00KD ,40.00 AED/SAR/QR, 3.75 BD/OMR
2 - 4934761488370 Approx.dia. 23 cm 2.00KD ,30.00 AED/SAR/QR, 2.50 BD/OMR
3 -4934761488387 Approx.dia. 19 cm 1.50KD ,20.00 AED/SAR/QR, 2.00 BD/OMR
4 -4934761488394 Anprox.dia. 15 cm 1.00KD .15.00 AED/SAR/QR, 1.25 BD/OMR



Stone Beige Bowl For Curry

1 -4549337390386 Approx.dia. 24 × H 5 cm 3.5KD ,40.00 AED/SAR/QR, 4.00 BD/OMR
--





Porcelain Beige Square Plate / With Partition

1-4550002797164 | 25 × 18 × 2 cm
5.00KD, 60.00 AED/SAR/QR
6.50 BD/OMR

2-4550002797195 | 21 × 15 × 2 cm
4.00KD, 50.00 AED/SAR/QR
5.00 BD/OMR



Porcelain Beige Stacking Dip Bowl

4547315254521 | About dia. 7.5 × h 3.5 cm
0.75KD, 10.00 AED/SAR/QR
1.00 BD/OMR



Porcelain Beige Egg Cup

4549738306290 | Approx. dia. 5 × h 3.5 cm
1.75KD, 20.00 AED/SAR/QR
2.00 BD/OMR



Porcelain Beige Oval Plate

L-4934761383651 | 22 × 16 × 4.5 cm
3.00KD, 35.00 AED/SAR/QR
3.75 BD/OMR

M-4934761383569 | 14.5 × 10.5 × 3.5 cm
1.75KD, 20.00 AED/SAR/QR
2.00 BD/OMR



Porcelain Beige Cup

1-4547315916252 | 330ml 2.00KD,
25.00 AED/SAR/QR, 2.50 BD/OMR
2-4547315916245 | 210ml 1.75KD,
20.00 AED/SAR/QR, 2.25 BD/OMR



Porcelain Beige Dish For Curry Rice

4934761383552 | 26 × 19.5 × 5 cm 5.00KD,
60.00 AED/SAR/QR, 6.50 BD/OMR



Porcelain Beige Tea Pot

4550002797171 | Approx. 450 ml 8.00KD,
100.00 AED/SAR/QR, 10.00 BD/OMR



Porcelain Beige Dripolator

4550002797188 | 11.5 × 9.5 cm 5.00KD,
60.00 AED/SAR/QR, 6.50 BD/OMR



White Porcelain:

White Porcelain Dish

XI-4547315873661 | Approx.dia. 26 cm **9.00KD,**

90.00 AED/SAR/QR, 12.00BD/OMR

L- 4547315873678 | Approx.dia. 22 cm

5.00KD/BD/OMR, 50.00 AED/SAR/QR

M-4548718358212 | About dia. 19cm **3.50KD**

40.00 AED/SAR/QR, 4.50 BD/OMR

S-4548718358229 | About dia. 14.5 cm **2.00KD**

30.00 AED/SAR/QR, 2.50BD/OMR



White Porcelain Square Bowl

L-4547315873791 | 14.5 × 14.5 × 6 cm

3.50KD, 40.00 AED/SAR/QR, 4.50 BD/OMR

M- 4547315873814 | 11.5 × 11.5 × 5 cm

2.50KD, 35.00 AED/SAR/QR, 3.25 BD/OMR

S-4547315873807 | 8 × 8 × 4cm **1.75KD, 30.00**

AED/SAR/QR, 2.25 BD/OMR



White Porcelain Donburi Bowl

L-4547315913053 | Dia. 16 × 8.5 cm

4.00KD, 50.00 AED/SAR/QR, 5.00 BD/OMR

S- 4547315581191 | About dia 13.5 × 7cm

1.75KD ,30.00 AED/SAR/QR, 2.25BD/OMR



White Porcelain Rice Bowl

XL- 4548076421535 | Approx.dia. 13.5 × H 5.5 cm **2.50KD,**

40.00 AED/SAR/QR, 3.25BD/OMR

L- 4547315873746 | Approx.dia. 12.3 × H 5.5 cm **2.25KD,**

35.00 AED/SAR/QR, 3.00 BD/OMR

M- 4547315873753 | Approx.dia. 11.6 × H 5 cm **2.00KD, XL**

30.00 AED/SAR/QR, 2.50 BD/OMR



White Porcelain Shallow Bowl

L-4547315873821 | Dia. 15.5 × 5 cm

2.50KD, 30.00 AED/SAR/QR, 3.25 BD/OMR

S- 4548718358243 | About dia. 11.5 × 4 cm

1.75KD, 20.00 AED/SAR/QR, 2.25 BD/OMR



White Porcelains Noodle Bowl

1- 4945247547917 | About dia. 21 cm **6.00KD**

80.00 AED/SAR/QR, 7.50 BD/OMR



White Porcelain Tea Pot

L-4550182308761 | 550 ml **8.00KD,**

100.00 AED/SAR/QR, 10.00 BD/OMR

S- 4550182308754 | 360 ml **7.00KD,**

90.00 AED/SAR/QR, 9.00 BD/OMR



White Porcelain Long Square Dish

L- 4547315873715 | 22.4 × 6.7 cm **2.50KD**
,30.00 AED/SAR/QR, 3.50 BD/OMR
S-4547315873722 | 11 × 6.5 cm **1.75KD** ,
20.00 AED/SAR/QR, 2.50 BD/OMR



White Porcelain Square Dish

XL- 4547315873739 | 22.4 × 12.2cm **3.50KD**
50.00 AED/SAR/QR, 4.50 BD/OMR,
L-4548076421511 | 18 × 18 cm **6.00KD**
80.00 AED/SAR/QR, 7.50 BD/OMR
M-4548076421528 | 12 × 12 cm **2.50KD**
35.00 AED/SAR/QR, 3.25 BD/OMR



White Porcelain Brevoort Plate

1-4934761052182 | W 31 × D11 × 2.5cm
6.00KD, 80 AED/SAR/QR, 7.50 BD/OMR



White Porcelain Small Bowl

4547315550203 | About dia. 8.5 × 6.5 cm
1.50KD, 20.00 AED/SAR/QR, 2.00BD/OMR



White Porcelain Mug Cup

4547315873913 | 325 ml **2.50KD**
35.00 AED/SAR/QR, 3.25BD/OMR



White Porcelain Small Dish

4548718358236 | About dia. 10 cm **1.50KD**
,20.00 AED/SAR/QR, 2.00 BD/OMR



White Porcelain Soy Sauce Pot Small

4547315873944 | Dia. 6.2 × 8 cm **3.50KD,**
50.00 AED/SAR/QR, 4.50 BD/OMR



White Porcelain Ramen Multi Bowl

4547315581207 | About dia. 20 × 6.5 cm
3.50KD, 50.00 AED/SAR/QR, 4.50 BD/OMR



White Porcelain Chinese Spoon

4549738306306 | 14cm
1.75KD, 20.00 AED/SAR,
19.00QR, 2.25 BD/OMR



White Porcelain Tea Cup

4547315581214 | 230 ml **2.00KD,**
25.00 AED/SAR/QR, 3.00 BD/OMR



White Porcelain Round Tea Cup

4547315873890 | 180 ml **1.75KD,**
25.00 AED/SAR/QR, 2.25 BD/OMR

Housekeeping



Why MUJI Cleaning Systems?

Reliable, robust and multipurpose household utilities are the foundation of a clean and organised household. The utility range offers practical and dependable products for washing, cleaning and recycling:

- Maximum cleaning, minimum storage
- Light-weight telescopic pole
- Seven different attachments
- Choose from lint roller, duster, broom, brush or mop
- Replaceable, highly durable, parts

With the seven attachments you can clean any area of your house; high places, low places, floors, windows and bathrooms.

Quick & Clean Everyday!



1- Cleaning System Aluminium Telescope Pole

4550182221084 | Approx.dia 2.5 × L 68-116 cm.

2.50 KD, 30.00 AED/SAR/QR, 3.25 BD/OMR

3- Cleaning System Wooden Pole

4550182221114 | Approx.dia 2 × h 110 cm.

7.00 KD, 80.00 AED/SAR/QR, 8.50BD/OMR

5-Cleaning System Bath Brush

4550002526153 | Approx.W 7 × D 15 × H 20 cm.

1.75 KD, 20.00 AED/SAR/QR, 2.00 BD/OMR

7- Carpet Cleaner For Cleaning System

4547315259625 | W 18.3 × D 7.5 × H 27.5 cm.

3.00 KD, 35.00 AED/SAR, 30.00 QR, 3.50 BD/OMR

9- Flooring Mop

4549738936954 | Approx.W 25 × D 10 × H 16.5 cm.

3.00 KD, 35.00 AED/SAR, 30.00 QR, 3.50 BD/OMR

11- Handy Mop For Cleaning System

4547315259748 | About 42 cm.

5.00 KD, 60.00 AED/SAR, 55.00 QR, 6.00 BD/OMR

2- Cleaning System Lightweight Short Pole

4550182221091 | Approx.dia 2 × h 56 cm.

1.25 KD, 30.00 AED/SAR/QR, 1.5 BD/OMR

4- Cleaning System Wooden Short Pole

4550182221107 | Approx.dia 2 × h 55 cm.

5.50 KD, 65.00 AED/SAR/QR, 7.00 BD/OMR

6- Cleaning System Deck Brush

4550002526160 | Approx.W 18 × D 7 × H 17 cm.

2.00 KD, 25.00 AED/SAR/QR, 2.50 BD/OMR

8- Cleaning System Broom

4550182107173 | Approx.W 22 × D 3 × H 23 cm.

2.50 KD, 30.00 AED/SAR/QR, 3.25 BD/OMR

10- Cleaning Supplies System Squeegee

4549337494695 | About W 24 × D 7 × H 18 cm.

2.50 KD, 30.00 AED/SAR, 25.00 QR, 3.25 BD/OMR

12-Cleaning System Sponge For Bath

4550002526146 | Approx.W 9.5 × D 15 × H 17 cm.

1.75 KD, 20.00 AED/SAR/QR, 2.00 BD/OMR



13- Spot Cleaning Series Brush

4550002526177 | Approx.W 1.5 × L 20 cm.

0.60 KD, 7.00 AED/SAR/QR, 0.80 BD/OMR

15- Spot Cleaning Series Sponge

4550002526184 | Approx.W 2 × L 20 cm.

0.60 KD, 7.00 AED/SAR/QR, 0.80 BD/OMR

17- Brush For Tile Joint

4547315259816 | About W 3 × D 19 × H 9.5 cm.

1.25 KD, 15.00 AED/SAR, 12.00 QR, 1.50 BD/OMR

19- Wooden Gap Brush

4549337287693 | Approx.W 1 × D 17 × H 2 cm.

1.75 KD, 20.00 AED/SAR, 15.00 QR, 2.50 BD/OMR

21- Wooden Table Brush

4550182107166 | Approx.W 23 × D 1 × H 7 cm.

4.50 KD, 50.00 AED/SAR/QR, 6.00 BD/OMR



14- Spot Cleaning Series Spatula

4550002526214 | Approx.W 1 × L 20 cm

0.60 KD, 7.00 AED/SAR/QR, 0.80 BD/OMR

16- Spot Cleaning Series SpotBrush

4550002526184 | Approx.W 1 × L 20 cm

0.60 KD, 7.00 AED/SAR/QR, 0.80 BD/OMR

18- Urethane Foam 3 Layer Bath Sponge

4549738304623 | About W 7 × D 14.5 × H 4.5 cm

2.00 KD, 20.00 AED/SAR, 15.00 QR, 2.50 BD/OMR

20- Desk Broom Set With Dustpan

4547315259809 | Approx.W 16 × D 4 × H 17 cm

3.00 KD, 35.00 AED/SAR, 30.00 QR, 3.50 BD/OMR

22- Dustpan For Cleaning System

4547315259700 | About W 25 × D 34 × H 10.5 cm

1.25 KD, 15.00 AED/SAR, 12.00 QR, 1.50 BD/OMR



1- Portable Lint Roller
4550002526283 | Approx. dia 3 × H 10 cm.
1.75 KD, 20.00 AED/SAR/QR, 2.00 BD/OMR

2- Microfiber Mini Handy Mop (Sliding Handle)
4547315259786 | About L 30-72cm.
4.00 KD, 50.00 AED/SAR, 45.00 QR, 5.00 BD/OMR

3- Lint Roller
4547315268368 | About W 6 × D 6 × H 21 cm.
2.50 KD, 30.00 AED/SAR, 25.00 QR, 3.00 BD/OMR

4- Mini Handy Duster Micro
4547315259779 | About L 33 cm.
3.00 KD, 35.00 AED/SAR, 30.00 QR, 3.50 BD/OMR

5-Cleaning System Flooring Mop Case
4549738755678 | Approx. W 27 × D 9 × H 15 cm.
2.50 KD, 30.00 AED/SAR/QR, 3.00 BD/OMR

6-Microfiber Mop (Dry)
4547315259649 | Approx. W 29 × D 14.5 × H 2.5 cm.
2.50 KD, 30.00 AED/SAR, 25.00 QR, 3.00 BD/OMR

7-Microfiber Mop (Wet)
4547315259656 | Approx. W 29 × D 14.5 × H 1.5 cm.
2.50 KD, 30.00 AED/SAR, 25.00 QR, 3.00 BD/OMR



Housekeeping / Spare & Refill



1- Adhesive Roller Refill
4549738307266 | 16 cm.
2.00 KD, 25.00 SAR/AED

2- Lint Roller Travel Refill
4547315268375 | 8 cm
1.250 KD, 15.00 SAR/AED

3- Portable Lint Roller Refill
4550002526290 | 2 rolls
1.25 KD, 15.00 SAR/AED

4-Cleaning System Sponge For Bath Refill
4550002710422 | Approx. W 9 × D 15 × H 17 cm
1.250 KD, 15.00 SAR/AED

5- Spare Sponge Squeegee
4549738364566 | About 24 × 4 cm.
1.00 KD, 12.00 SAR/AED

6- Refill Spatula for Glass Wiper
4549738320838 | Approx. 24× 2cm
0.900 KD, 10.00 SAR/AED

7- Refill Sheets for Flooring Mop Dry
4550002526269 | 20 sheets
.75 KD, 12.00 SAR/AED

8- Spare Brush For Handy Mop
4547315259793 | About. 18 cm
2.00 KD, 20.00 SAR/AED
4547315259755 | About. 30 x 17 cm
3.50 KD, 45.00 SAR/AED

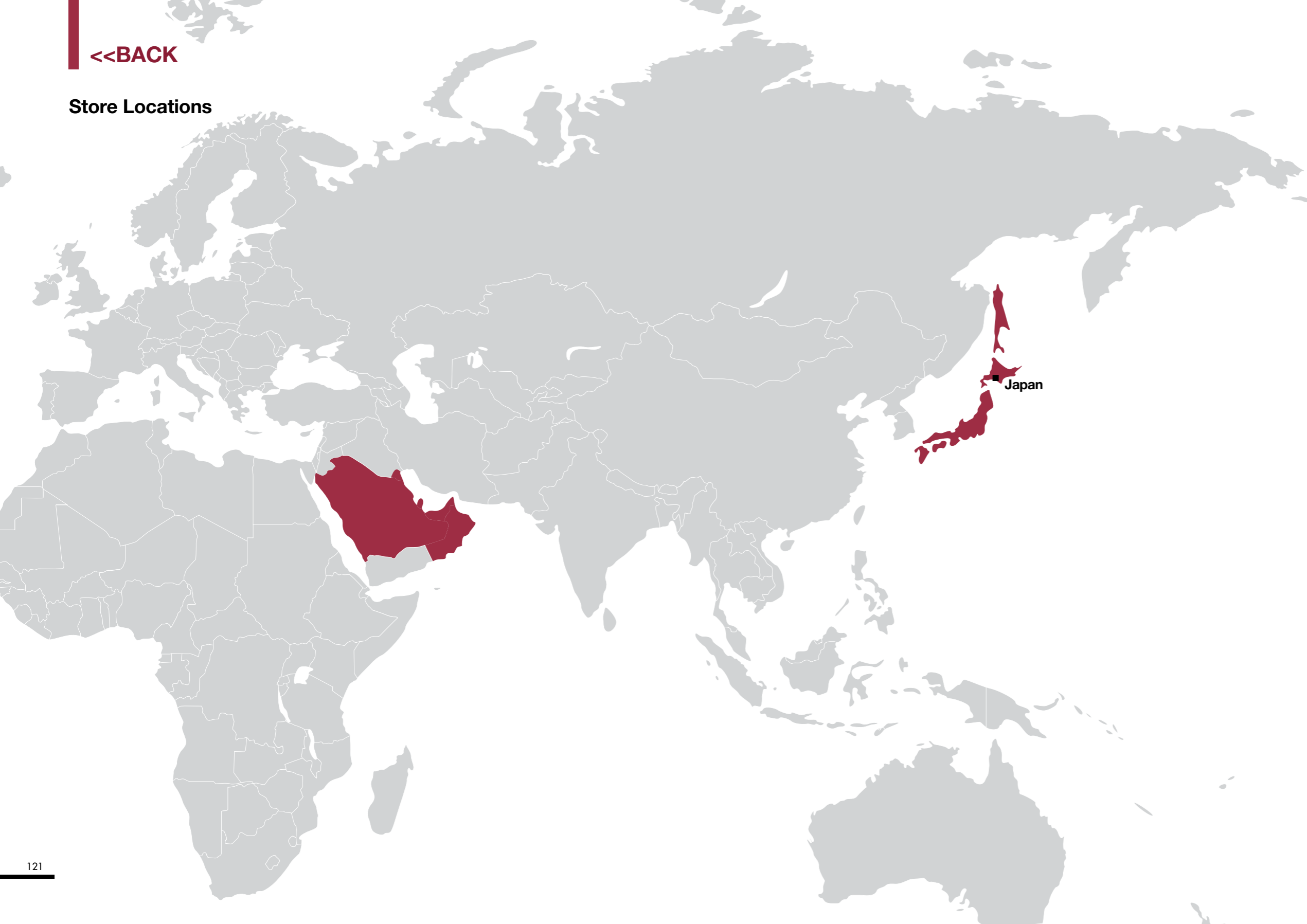

Over 800 stores around the world

1. UAE:

Dubai:

The Dubai Mall: (+971) 4 419 0205 / 06 / 07
City Centre Mirdif: (+971) 4 419 0670 / 69 / 68
The Beach, opposite JBR: (+971) 4 419 0868 / 69
Mall of the Emirates (Debenham's Concession): (+971) 4 419 0472

Abu Dhabi:

Yas Mall: (+971) 2 492 6555 / 56 / 57
Al Wahda Mall : (+971) 2 695 8230 / 40
The Galleria, Al Maryah Island : (+971) 2 492 6790 / 91
Jimi Mall: (+971) 3 701 8110 / 11

2. KSA

Red Sea Mall: (+966) 12 261 7474 / 79
Hayat Mall: (+966) 11 510 1237 / 38
Riyadh Gallery: (+966) 11 510 1491 / 90
Riyadh Park: (+966) 11 520 3564 / 65
Alrashid Mall: (+966) 13 667 8719

3. Kuwait

Grand Avenue - The Avenues: (+965) 2 228 3147 / 48
2nd Avenue - The Avenues, First Floor: (+965) 2 228 3797 / 98
Al Kout Mall: (+965) 2 208 1149 / 34

4. Qatar

Doha Festival City: (+974) 4 452 1463 / 64
Villaggio: (+974) 4 452 9059/60

5. Bahrain

City Centre Bahrain: (+973) 1 711 0385 / 86
The Avenues - Bahrain: (+973) 1 711 0561 / 62

6. Oman

Mall of Muscat: (+968) 22303560 / 61



-The selection of goods available may vary between individual stores.

-Size specifications represent gross external measurements and are for guidance only.

-If the size margin of a product is critical to your chosen function we recommend that you obtain accurate measurements instore.

-Please note that colours may vary slightly between catalogue image and actual product. Whilst every effort is made to ensure that all products featured are in constant supply, we apologise if any item is occasionally out of stock due to customer demand. Some items are seasonal and may only be stocked for short periods of time.

MUJI online ecommerce

Coming soon.....

<https://www.alshaya.com/en/brands/fashion-footwear/muji/>

<http://www.muji.com/ae-en>