



Catalogue  
**2020**



Download your copy!

**MUJI**  
無印良品





Select product codes & call or contact us on  
**WhatsApp for business: +9651821212**  
**WhatsApp direct: +96597264813**



**Home Delivery** - Processed and shipped between **2 to 6 business days**  
*Excluding Fridays & public holidays.*

Delivery cost is KD 3 or *Free delivery* on orders *KD 8 and above.*



## What is MUJI?

### “NO LABEL. QUALITY GOODS”

MUJI is derived from its Japanese name ‘Mujirushi Ryohin’ which means ‘no label quality goods’. The brand launched in Japan in the 1980s with its no label, value-led, less is more concept.

MUJI is a renowned producer of stylish, functional and affordable quality goods that are relevant to all aspects of urban living, whether at work, rest or play.

Today MUJI has more than 800 stores worldwide and offers various consumer related products, including; household goods, stationery, travel accessories, beauty products and fashion.

In the Middle East, MUJI has stores in Kuwait, UAE, KSA, Bahrain, Qatar and Oman.





# MUJI Philosophy & Values

## Philosophy

- 1. Selection of materials:**  
We use many recycled materials, with an emphasis on quality. This enables us to create low-priced, high-quality products.
- 2. Streamlining processes:**  
Processes that have no bearing on a product's quality such as sorting, sizing, and polishing are eliminated. Focusing on true quality, MUJI's processes eliminate waste and reduce costs.
- 3. Simplification of packaging:**  
MUJI seeks to highlight products' natural colors and shapes. MUJI products appear in simple packaging bearing only product related information and a price tag.

## Values

- 1.** MUJI is not a brand whose value rests in the frills and "extras"
- 2.** MUJI is simplicity – but a simplicity achieved through a complexity of thought and design
- 3.** MUJI's streamlining is the result of careful elimination of gratuitous features and design unrelated to function
- 4.** MUJI, the brand, is rational, and free of agenda, doctrine, and "isms"
- 5.** MUJI aspires to modesty and plainness, to appeal to a wide group of people



# BEST SELLERS!

## ★ Aroma Diffuser



### Ultrasonic Aroma Diffuser

4547315880621 / Small -

29.00 KD, 315.00 SAR/AED, 299.00 QR, 35.00 BD/OMR

The ultrasonic waves spread the aroma to enjoy together with the lights. The white cylinder houses a lamp that shines with an ambient glow and has 2 light settings.

### Ultrasonic Aroma Diffuser

4549738380283 / Large -

39.00 KD, 415.00 SAR/AED, 399.00 QR, 45.00 BD/OMR

Plenty of mist with pleasure of aroma even in a large room. 3-2 drops of essential oils for 100ml of water

## ★ Essential Oils

### Herb & Flower

Herb aroma is recommended for relaxing.



### ★ Lemongrass

4550002546663 30 ml

11.00 KD, 130.00 AED/SAR/QR, 13.00 BD/OMR

Its sharp refreshing scent produces a cooling sensation. It is known that insects show aversion to the smell.



### ★ Lavender

4550002546625 30 ml

11.00 KD, 130.00 AED/SAR/QR, 13.00 BD/OMR

Its woody based gentle floral scent eases tension and has calming effect.

## ★ Gusset Case Collection

This cloth gusset case can be used to store and organise bulky clothes when travelling. It can be folded into a pocket size so as to save space.

L-4550002868956 | 40 x 53 x 10 cm

6.50 KD, 80.00 SAR/AED, 80.00 QR, 7.75 BD/OMR



## ★ Floor Chair

This simple floor chair matches any kind of room.

A legless chair with covering. With 6-step reclining function.

4548718481286 | L, W 57 x D 102 x H 10 cm,

21.00 KD, 300.00 SAR/AED/QR, 27.00 BD/OMR



### Cotton Canvas Cover For Floor Chair

12.00 KD, 100.00 SAR/AED, 75.00 QR, 14.00 BD/OMR

4549337746886 - Ecru



4547315999699 - Dark Brown



4547315999057 - Beige



## ★ Down Blend Pillow

4549738994428 | 50 x 70 cm

30.00KD ,420.00 AED/SAR , 400.00 QR, 35 BD/OMR



## ★ Pp Storage Case Drawer / Wide Deep

4548718182800 | 14.00 KD, 170.00 SAR/AED, 160.00 QR, 17.00 BD/OMR

Approx. W 55 x D 44.5 x H 30 cm



## ★ Acrylic Stand For Glasses

4934761174280 | 16.00 KD, 185.00 SAR/AED, 175 QR, 19 BD/OMR

Approx. W 6.7 x D 17.5 x H 25 cm



## ★ Acrylic Stand For Glasses

4549738970125 | 16.00 KD, 195.00 SAR/AED, 185.00 QR, 19.00 BD/OMR

Approx. W 25.5 x D 17 x H 9.5 cm



## ★ Acrylic Box 2 Drawer / L

4549738300397 | 16.00 KD, 195.00 SAR/AED, 185.00 QR, 19.00 BD/OMR

Approx. W 25.5 x D 17 x H 9.5 cm



## ★ Velour Partition

Velour Partition 3 x 5 / Grey

4549738373544 | 6.00 KD, 70.00

SAR/AED/QR, 8.00 BD/OMR

Approx. W 15.5 x D 12 x H 2.5 cm

Velour With Ring Partition / L / Grey

4549738373551 | 6.00 KD, 90.00 SAR/AED,

85.00 QR, 7.00 BD/OMR

Approx. W 23.5 x D 15.5 x H 2.5 cm



## ★ PP Storage Case Drawer / Wide / L

4945247266740 | 12.50 KD, 145.00 SAR/AED, 135.00 QR, 16.00 BD/OMR

Approx. W 55 x D 44.5 x H 24 cm



## ★ PP Storage Case Drawer / Wide / M / 4 Row

4548718510269 | 30.00 KD, 370.00 SAR/AED, 350.00 QR, 40.00 BD/OMR

Approx. W 55 x D 44.5 x H 90 cm



# Index

<b>Household</b>	<b>1</b>	
Acrylic Storage Units	Makeup PP Storage	Buri Storage Units
Rattan Storage Units	Cotton Linen Storage Units	Polypropylene Storage Boxes
Stacking Shelves	Furniture	Tableware
Housekeeping		
<b>Electronics</b>	<b>67</b>	
<b>Travel</b>	<b>71</b>	
Luggage	Travel Accessories	Bags & Totes
<b>Health &amp; Beauty</b>	<b>81</b>	
Essential Oils	Aroma Diffuser	Skin Care
Nail Care	PET Bottles	Cosmetic Tools
Cut Cotton & Cotton Buds	Nylon Makeup Boxes	
<b>Stationery</b>	<b>99</b>	
Pens	Notebooks	Arts & Crafts
Office Stationery	Frames	ABS Collection
<b>Fashion</b>	<b>121</b>	
Men's wear	Ladies wear	Children's wear
Pajamas		
<b>Location</b>	<b>147</b>	





# Household



Buri Storage Unit 13



Rattan Storage Unit 14



Cotton Linen Storage Unit 15



Polypropylene Storage Box 17



Stacking Shelf 25



Furniture 29



Acrylic Storage Units 3



Makeup PP Storage 9



Tableware 47



Housekeeping 59

## Acrylic Storage Unit

Acrylic storage units feature scratch resistance as well as transparency that allows you to identify the contents from the outside. MUJI offers a wide variety of acrylic storage units suitable for any purpose or space, such as desktop or the living room.



**Acrylic Box 2 Drawer / L**

4549738300397  
 16.00 KD, 195.00 SAR/AED,  
 185.00 QR, 19.00 BD/OMR  
 Approx. W 25.5 x D 17 x H 9.5 cm  
 \* Stacking limit: 2 units



**Acrylic Box 2 With Lid 2 Drawer / L**

4549738970125  
 16.00 KD, 195.00 SAR/AED,  
 185.00 QR, 19.00 BD/OMR  
 Approx. W 25.5 x D 17 x H 9.5 cm  
 \* Stacking limit: 2 units



**Acrylic Box 5 Drawer**

4547315915491  
 20.00 KD, 240.00 SAR/AED,  
 225.00 QR, 23.00 BD/OMR  
 Approx. W 25.5 x D 17 x H 16 cm  
 \* Stacking limit: 2 units



**Acrylic Box 3 Drawer**

4547315915507  
 16.00 KD, 185.00 SAR/AED,  
 175.00 QR, 19.00 BD/OMR  
 Approx. W 25.5 x D 17 x H 10 cm  
 \* Stacking limit: 2 units



**Acrylic Box 2 Drawer**

4945247380910  
 11.00 KD, 135.00 SAR/AED,  
 125.00 QR, 14.00 BD/OMR  
 Approx. W 17.5 x D 13 x H 9.5 cm  
 \* Stacking limit: 2 units



**Acrylic Box With Lid 2 Drawer**

4945247380965  
 11.00 KD, 135.00 SAR/AED,  
 125.00 QR, 14.00 BD/OMR  
 Approx. W 17.5 x D 13 x H 9.5 cm  
 \* Stacking limit: 2 units



**Acrylic Storage Box 3 Drawer**

4549738907589  
 21.00 KD, 250.00 SAR/AED,  
 225.00 QR, 28.00 BD/OMR  
 A4



**Acrylic Box 6 Drawers A4**

4549738907572  
 24.00 KD, 300.00 SAR/AED,  
 285.00 QR, 27.00 BD  
 A4



**Acrylic Rack L**

4547315296309  
 9.00 KD, 105.00 SAR/AED,  
 100.00 QR, 11 BD/OMR  
 Approx. W 17.5 x D 13 x H 14.3 cm



Usage example



**Acrylic Rack S**

4547315296286  
 7.50 KD, 90.00 SAR/AED,  
 85.00 QR, 10 BD/OMR  
 Approx. W 8.8 x D 13 x H 4.3 cm



Usage example



**Acrylic Stand For Pierced Earrings & Necklaces**

4548718958207  
 11.00 KD, 135.00 SAR/AED,  
 125.00 QR, 14 BD/OMR  
 Approx. W 6.7 x D 13 x H 25 cm



Usage example



**Acrylic Stand For Glasses**

4934761174280  
 16.00 KD, 185.00 SAR/AED,  
 175 QR, 19 BD/OMR  
 Approx. W 6.7 x D 17.5 x H 25 cm



Usage example





**Stackable Acrylic Box / Cover For Tissues**  
4550002855963  
1.50 KD, 20.00 SAR/AED/QR, 1.75 BD/OMR  
Approx. L: W 24.6 × H 12 cm



**Stackable Acrylic Box / Tray**  
4550002856083  
1.250 KD, 15.00 SAR/AED/QR, 1.50 BD/OMR  
Approx. W 25.9 × D 9.1 × H 1.3 cm



**Stackable Acrylic Box / Lid**  
4550002856076  
0.50 KD, 7.00 SAR/AED/QR, 0.75 BD/OMR  
Approx. W 8.4 × D 8.4 cm



**Stackable Acrylic Box / M**  
4550002855918  
5.00 KD, 60.00 SAR/AED/QR, 6.00 BD/OMR  
Approx. W 25.2 × D 12.6 × H 8 cm



**Acrylic Display Case With Sliding Doors / L**  
4550002856113  
12.00 KD, 150.00 SAR/AED/QR, 15.00 BD/OMR  
Approx. L: W 33.6 × D 8.4 × H 24.4 cm  
S: W 25.2 × D 8.4 × H 18.4 cm



**Acrylic 6 Drawer**  
4549337268142  
20.00 KD, 240.00 SAR/AED, 225.00 QR, 23.00 BD/OMR  
Approx. W 8.7 × D 17 × H 25.2 cm



**Acrylic 3 Drawer**  
4934761798202  
16.00 KD, 185.00 SAR/AED, 175.00 QR, 19.00 BD/OMR  
Approx. W 8.7 × D 17 × H 25.2 cm



**Acrylic Unit - 1 Drawer**  
4934761798196  
11.00 KD, 135.00 SAR/AED, 125.00 QR, 14.00 BD/OMR  
Approx. W 25.2 × D 17 × H 8.7 cm

**Stackable Acrylic Box / L**  
4550002855901  
6.50 KD, 80.00 SAR/AED/QR, 8 BD/OMR  
Approx. L: W 25.2 × D 12.6 × H 16 cm

**Stackable Acrylic Box / L / Half**  
4550002855932  
4.50 KD, 50.00 SAR/AED/QR, 5.5 BD/OMR  
Approx. W 12.8 × D 12.8 × H 16 cm

**Stackable Acrylic Box / L / Small**  
4550002856045  
1.750 KD, 25.00 SAR/AED/QR, 2.25 BD/OMR  
Approx. W 8.4 × D 8.4 × H 9 cm



**Stackable Acrylic Box / M / Half**  
4550002855949  
3.50 KD, 40.00 SAR/AED/QR, 4.5 BD/OMR  
Approx. W 12.6 × D 12.6 × H 8 cm



**Stackable Acrylic Box / M / Small**  
4550002856052  
1.50 KD, 20.00 SAR/AED/QR, 1.75 BD/OMR  
Approx. W 8.4 × D 8.4 × H 6 cm



**Stackable Acrylic Box / S**  
4550002855925  
3.50 KD, 40.00 SAR/AED/QR, 4.5 BD/OMR  
Approx. W 25.2 × D 12.6 × H 4 cm



**Stackable Acrylic Box / S / Half**  
4550002855956  
2.50 KD, 30.00 SAR/AED/QR, 3.5 BD/OMR  
Approx. W 12.6 × D 12.6 × H 4 cm



**Acrylic Divider / L**  
4547315902194  
9.00 KD, 105.00 SAR/AED, 100.00 QR, 11.00 BD/OMR  
Approx. W 26.8 × D 21 × H 16 cm



**Acrylic Divider / S**  
4547315902200  
7.50 KD, 90.00 SAR/AED, 85 QR, 10.00 BD/OMR  
Approx. W 13.3 × D 21 × H 16 cm



**Acrylic Case For Glasses**  
4549738671497  
17.00 KD, 200.00 SAR/AED/QR, 23.00 BD/OMR  
Closed: Approx. W 17.5 × D 8.8 × H 25 cm  
Opened: Approx. W 35 × D 4.4 × H 25 cm



**Acrylic Stand For Letters / Wide**  
4550002856168  
4.00 KD, 50.00 SAR/AED/QR, 5.00 BD/OMR  
Approx. W 8.7 × D 13 × H 13 cm



**Stackable Acrylic Box / S / Small**  
4550002856069  
1.250 KD, 15.00 SAR/AED  
Approx. W 8.4 × D 8.4 × H 3 cm



**Stackable Acrylic Box 1**  
4550002855994  
1.50 KD, 20.00 SAR/AED/QR, 1.75 BD/OMR  
Approx. W 12 × D 12 × H 7.2 cm



**Stackable Acrylic Box 3**  
4550002856014  
1.00 KD, 10.00 SAR/AED/QR, 1.25 BD/OMR  
Approx. W 12 × D 12 × H 3.3 cm



**Stackable Acrylic Shoes Case**  
4550002856144  
15.00 KD, 200.00 SAR/AED/QR, 15.00 BD/OMR  
Approx. W 25 × D 32 × H 12.5 cm



**Acrylic Pen Pot Rectangular**  
4549337528574  
1.50 KD, 20.00 SAR/AED, 15.00 QR, 2.00 BD/OMR  
Approx. W 5.5 × D 4.5 × H 9 cm



**Acrylic Stand With Partition**  
4934761407845  
11.00 KD, 135.00 SAR/AED, 125 QR, 14.00 BD/OMR  
Approx. W 25.8 × D 17.5 × H 6.1 cm  
\* Stacking limit: 2 units



**Acrylic Storage / 3 Tiers**  
4549337318533  
9.00 KD, 105.00 SAR/AED, 100 QR, 11.00 BD/OMR  
Approx. W 17.5 × D 6.5 × H 23 cm  
\* Do not store oil-based solutions, such as essential oils and body oils, in this stand.



**Stackable Acrylic Box / Cover for Paper Towels**  
4550002855970  
1.750 KD, 25.00 SAR/AED/QR, 2.25 BD/OMR  
Approx. W 24.8 × D 12 × H 3 cm  
\* Do not store oil-based solutions, such as essential oils and body oils, in this stand.



**Stackable Acrylic Box / Divider**  
4550002856106  
1.250 KD, 15.00 SAR/AED/QR, 1.5 BD/OMR  
Approx. W 5.8 × D 8.4 × H 5.7 cm



**Stackable Acrylic Box / Desktop Card Box**  
4550002856090  
1.250 KD, 15.00 SAR/AED/QR, 1.5 BD/OMR  
Approx. W 10 × D 8.4 × H 4.5 cm



**Acrylic Partition Shelf / L**  
4547315919840  
5.50 KD, 70.00 SAR/AED, 65.00 QR, 7.00 BD/OMR  
Approx. W 26 × D 17.5 × H 16 cm



**Acrylic Partition Shelf / S**  
4547315919833  
4.250 KD, 50.00 SAR/AED, 45.00 QR, 5.00 BD/OMR  
Approx. W 26 × D 17.5 × H 10 cm



**Acrylic Smart Phone Stand / L**  
4550002856212  
4.00 KD, 50.00 SAR/AED/QR, 5.00 BD/OMR  
Approx. W 16.8 × D 8.4 × H 9 cm



**Acrylic Smart Phone Stand / S**  
4550002856229  
3.50 KD, 40.00 SAR/AED/QR, 4.5 BD/OMR  
Approx. W 8.4 × D 8.4 × H 9 cm



**Velour Partition / Grey**

4549738373575  
3.50 KD, 50.00 SAR/AED, 45.00 QR, 4.00 BD/OMR  
Approx. W 15.5 x D 12 x H 2.5 cm



Usage example



**Velour Partition 3 x 5 / Grey**

4549738373544  
6.00 KD, 70.00 SAR/AED/QR, 8.00 BD/OMR  
Approx. W 15.5 x D 12 x H 2.5 cm



Usage example



**Velour Partition Large / Grey**

4549738373568  
6.00 KD, 90.00 SAR/AED, 85.00 QR, 7.00 BD/OMR  
Approx. W 23.5 x D 15.5 x H 2.5 cm



Usage example



**Velour With Ring Partition Large / Grey**

4549738373551  
6.00 KD, 90.00 SAR/AED, 85.00 QR, 7.00 BD/OMR  
Approx. W 23.5 x D 15.5 x H 2.5 cm



Usage example



**Velour Case For Glass Stand Grey**

Grey  
4550002119577  
2.50 KD, 30.00 SAR/AED/QR, 3.25 BD/OMR  
Approx. W 3.7 x D 16.7 x H 2 cm



Usage example



**Velour Case For Earring Stand Grey**

4550002119560  
2.50 KD, 30.00 SAR/AED/QR, 3.25 BD/OMR  
Approx. W 3.7 x D 16.7 x H 2 cm



Usage example





## PP Storage (Makeup)

You can choose the polypropylene makeup case best suited to what you want to store inside. Cases of the same size can be stacked and are ideal for storing small objects.



**PP Makeup Box**

4549337495548  
3.250 KD, 45.00 SAR/AED/QR,  
3.5 BD/OMR  
Approx. W 15 × D 22 × H 16.9 cm



**PP Makeup Box 1/2**

4549337495555  
2.250 KD, 35.00 SAR/AED/QR,  
2.5 BD/OMR  
Approx. W 15 × D 22 × H 8.6 cm



**PP Nylon Makeup Box 1/4**

4549337495562  
1.50 KD, 25.00 SAR/AED/QR,  
1.75 BD/OMR  
Approx. W 15 × D 22 × H 4.5 cm



**PP Makeup Tray Mirror**

4549337495609  
5.250 KD,  
70.00 SAR/AED/  
QR, 5.50 BD/  
OMR  
Approx. W 15 × D  
22 × H 2 cm  
This product can be placed both  
vertically and horizontally. Also can  
be used in place of a lid when  
combined with PP Vanity Cases.



**PP Makeup Box W/Lid L**

4549337495616  
3.250 KD, 45.00 SAR/AED/QR,  
3.5 BD/OMR  
Approx. W 15 × D 22 × H 10.3 cm



**PP Makeup Box W/Lid S**

4549337495623  
2.00 KD, 30.00 SAR/AED/QR,  
2.25 BD/OMR  
Approx. W 15 × D 11 × H 10.3 cm



**PP Makeup Box Half / 1/2**

**Size W/Partition**  
4549337497696  
2.00 KD, 30.00 SAR/AED/QR,  
2.25 BD/OMR  
Approx. W 15 × D 11 × H 8.6 cm



**PP Makeup Box Half / 1/4**

**Size W/Partition**  
4549337497702  
1.250 KD, 20.00 SAR/AED/QR,  
1.5 BD/OMR  
Approx. W 15 × D 11 × H 4.5 cm



**PP Makeup Storage Box 1/2**

**Half**  
4549337495586  
1.25 KD, 20.00 SAR/AED/QR,  
1.5 BD/OMR  
Approx. W 15 × D 11 × H 8.6 cm



**PP Makeup Box Half / 1/4**

**Size**  
4549337497764  
1.00 KD, 15.00 SAR/AED/QR,  
1.25 BD/OMR  
Approx. W 15 × D 11 × H 4.5 cm



**PP Makeup Storage Box 1/4 Half**

4549337495593  
1.50 KD, 25.00 SAR/AED/QR,  
1.75 BD/OMR  
Approx. W 7.5 × D 22 × H 4.5 cm



**PP Stand For Makeup Brush & Pencil**

4549337497672  
1.00 KD, 15.00 SAR/AED/QR,  
1.25 BD/OMR  
Approx. W 7.1 × D 7.1 × H 10.3 cm



**PP Case For Cotton Buds With Lid**

4549337495630  
Approx. W 10.7 × D 7.2 ×  
H 9.1 cm  
1.25 KD, 20.00 SAR/AED/QR,  
1.5 BD/OMR



**PP Case For Cotton & Cotton Buds**

4549337497665  
Approx. W 10.7 × D 7.2 ×  
H 7.7 cm  
1.00 KD, 15.00 SAR/AED/QR,  
1.25 BD/OMR

### Usable as small compartment storage boxes inside drawers.

These can be used as small compartment storage boxes for drawers in polypropylene storage boxes. This makes them useful for neatly organising small office objects such as stationery and storing small items that tend to get separated easily. Features round corners that make it easy to remove items from inside and semi-transparent material that allows you to see objects from the sides.



# Storage / Buri, Rattan & Cotton Linen



## Interior Advisor's Recommendation.

The standard dimensions of modules are based on "shaku", which is a unit of measurement used in the construction of Japanese homes. These dimensions are used in a wide variety of items ranging from large furniture to small storage items. For example, the height of a unit shelf is based on the height of a "kamoi" (lintel) or door, and shelf width is based on the width of a half "ken" (91 cm), so that they can fit neatly within the width of 1 "ken" (182 cm), between two columns.

### Unit shelf module dimensions "175 cm and 86 cm"

The 175 cm height corresponds the height of doors in Japanese homes. The 86 cm width is based on the "ken" (182 cm), which is a unit of measurement used in the construction of Japanese homes. "Outer width 86 cm, inner width 84 cm" which is slightly less than a half "ken" (91 cm), is a standard dimension for MUJI products.

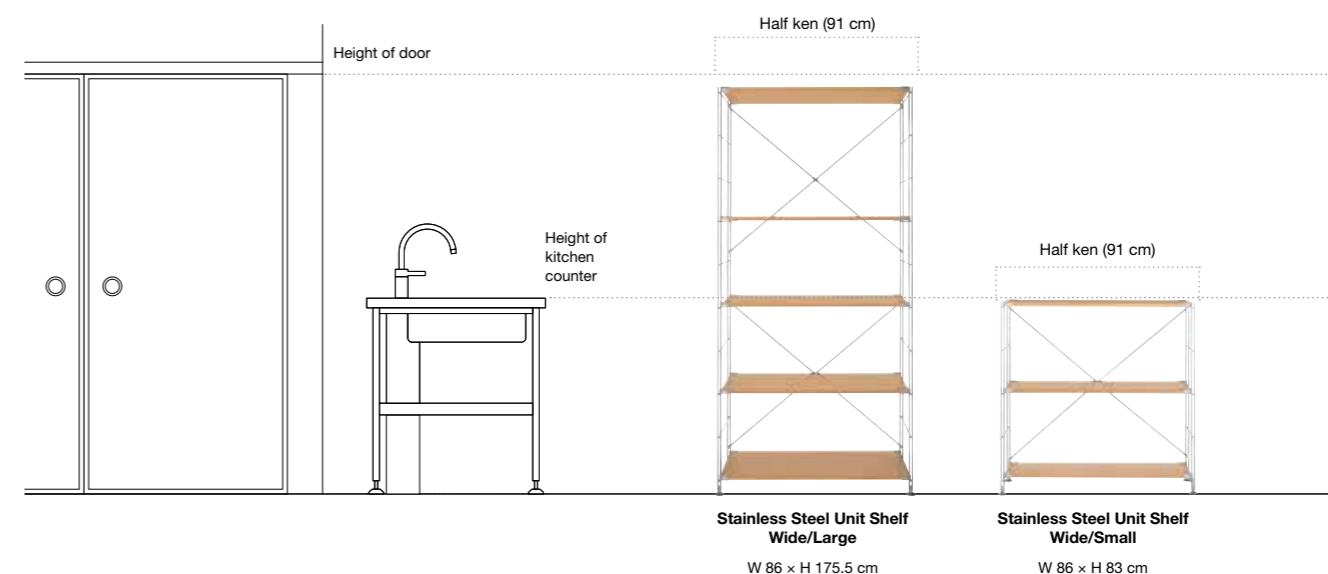

### Storage item module dimensions "37 cm and 26 cm"

Storage item modules are sized to fit neatly in storage furniture with dimensions of 175 cm and 86 cm. The module dimensions of 26 cm and 37 cm, which are designed to fit on shelves, are based on the inside dimensions of shelves (W 80 x H 35 cm).

#### Compatible storage items

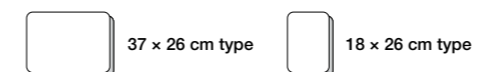

These modules fit in a unit shelf or stacking shelf.

These modules fit in a unit shelf.

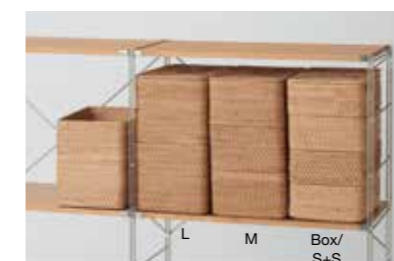

37 x 26 cm baskets arranged vertically



Arrangement of 37 x 37 cm baskets

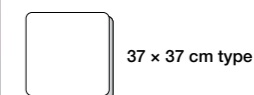

\* Size varies depending on the material.



## Buri Storage Unit

Hand-woven using high quality uncoated, unbleached buri from the Philippines that keeps its natural texture. Some of these highly functional storage baskets also come with lids and handles.



**Stackable Buri Basket Rectangular / L**

4548718014002  
8.00 KD, 95.00 SAR/AED/QR,  
10.00 BD/OMR  
Approx. W 37 x D 26 x H 24 cm  
A4



**Stackable Buri Basket Rectangular / M**

4945247027914  
5.5 KD, 65.00 SAR/AED/QR,  
7.00 BD/OMR  
Approx. W 37 x D 26 x H 16 cm  
A4



**Stackable Buri Basket Rectangular / S**

4945247027907  
4.50 KD, 55.00 SAR/AED/QR,  
5.75 BD/OMR  
Approx. W 37 x D 26 x H 12 cm  
A4



**Stackable Buri Box Rectangular**

4945247027921  
3.00 KD, 40.00 SAR/AED/QR,  
3.75 BD/OMR  
Approx. W 26 x D 18.5 x H 12 cm

**Buri Basket Lid / Rectangular**

4548718014026  
1.50 KD, 20.00 SAR/AED/QR,  
2.00 BD/OMR  
Approx. W 37 x D 26 x H 2 cm  
\* This lid can be used with S, M, and L buri baskets.

**Buri Box Lid / Rectangular**

4548718014033  
1.00 KD, 15.00 SAR/AED/QR,  
1.25 BD/OMR  
Approx. W 26 x D 18.5 x H 2 cm



**Buri Basket Square / XL**

4945247027945  
10.00 KD, 120.00 SAR/AED/QR,  
13.00 BD/OMR  
Approx. W 35 x D 37 x H 32 cm



**Stackable Buri Basket Square / L**

4548718013999  
9.00 KD, 110.00 SAR/AED/QR,  
12.00 BD/OMR  
Approx. W 35 x D 37 x H 24 cm



**Stackable Buri Basket Square / M**

4945247027938  
6.00 KD, 75.00 SAR/AED/QR,  
7.5 BD/OMR  
Approx. W 35 x D 37 x H 16 cm

**Buri Basket Lid / Square**

4548718014019  
2.00 KD, 25.00 SAR/AED/QR,  
2.5 BD/OMR  
Approx. W 35 x D 37 x H 2 cm  
\* This lid can be used with M, L, and XL buri baskets.



The baskets come with sturdy frames and close fitting lids.

## Rattan Storage Unit

Rattan storage is light and easy to handle, as well as smooth to the touch. These stackable storage items are designed for ease of use, with convenient lids and handles.



**Stackable Rattan Basket Rectangular / L**

4945247381313  
15.00 KD, 180.00 SAR/AED,  
175.00 QR, 19.00 BD/OMR  
Approx. W 36 x D 26 x H 24 cm  
A4



**Stackable Rattan Basket Rectangular / M**

4945247381306  
12.50 KD, 145.00 SAR/AED,  
140.00 QR, 16.00 BD/OMR  
Approx. W 36 x D 26 x H 16 cm  
A4



**Stackable Rattan Basket Rectangular / S**

4945247381290  
11.00 KD, 125.00 SAR/AED,  
120.00 QR, 14.00 BD/OMR  
Approx. W 36 x D 26 x H 12 cm



**Stackable Rattan Box With Lid Rectangular**

4945247381337  
12.00 KD, 140.00 SAR/AED,  
135.00 QR, 15.5 BD/OMR  
Approx. W 26 x D 18 x H 16 cm

**Stackable Rattan Basket Lid Rectangular**

4547315004768  
5.00 KD, 60.00 SAR/AED, 55.00 QR, 6.5 BD/OMR  
Approx. W 36 x D 26 x H 3 cm  
\* Can be used with L / M / or S.



**Stackable Rattan Box Rectangular / S**

4945247381238  
11.00 KD, 125.00 SAR/AED,  
120.00 QR, 14.00 BD/OMR  
Approx. W 26 x D 18 x H 12 cm



**Rattan Box With Handle**

4945247028454  
7.00 KD, 85.00 SAR/AED,  
80.00 QR, 8.5 BD/OMR  
Approx. W 15 x D 22 x H 9 cm



**Stackable Rattan Basket Square / L**

4548718021826  
23.00 KD, 265.00 SAR/AED,  
260.00 QR, 29.00 BD/OMR  
Approx. W 35 x D 36 x H 24 cm



**Stackable Rattan Basket Square / M**

4548718021833  
16.00 KD, 190.00 SAR/AED,  
185.00 QR, 20.00 BD/OMR  
Approx. W 35 x D 36 x H 16 cm



**Rattan Tissue Box**

4547315815746  
11.00 KD, 130.00 SAR/AED,  
125.00 QR, 14.00 BD/OMR  
Approx. W 27.5 x D 14.5 x H 8.8 cm



**Stackable Rattan Laundry Basket**

4549738309819  
19.00 KD, 225.00 SAR/AED/QR,  
25.00 BD/OMR  
Approx. W 36 x D 26 x H 32 cm

### Country of origin of Rattan Basket

Rattan baskets sold by MUJI are made in Thai Binh province, northern Vietnam. Thai Binh province is a peaceful place with rice fields and free-range cows, buffalos, and chickens. In addition to farming, the area is also famous for its handcrafts, particularly items of woven rattan and bamboo.



### Making a Rattan Basket

The rattan, about 3-5 cm in diameter, must first be split into 5-9 mm strips before it can be used to make a basket. The rattan baskets are woven by hand, by farmers. This rattan basket takes a long time to weave, only 1-2 can be made in a day.



\* Usage example

## Cotton Linen Storage Unit

Coated on the inside, these fabric boxes can be folded compactly. The boxes are made based on MUJI's original size standard, which allow them to be combined with shelves and other items.



**Cotton-Linen Polyester**  
Soft Box Oblong / L  
4549738369738  
8.00 KD, 100.00 SAR/AED, 95.00 QR, 10.00 BD/OMR  
Approx. W 37 × D 26 × H 34 cm  
A4



**Cotton-Linen Polyester**  
Soft Box Oblong / M With Lid  
4549738369769  
8.50 KD, 105.00 SAR/AED, 105.00 QR, 10.00 BD/OMR  
Approx. W 37 × D 26 × H 26 cm  
A4



**Cotton-Linen Polyester**  
Soft Box Oblong / M  
4549738369776  
7.00 KD, 85.00 SAR/AED, 80.00 QR, 9.00 BD/OMR  
Approx. W 37 × D 26 × H 26 cm  
A4



**Cotton-Linen Polyester**  
Soft Box Oblong / S  
4549738369752  
6.00 KD, 70.00 SAR/AED, 65.00 QR, 8.00 BD/OMR  
Approx. W 37 × D 26 × H 16 cm  
A4



**Cotton-Linen Polyester Soft**  
Box L With Lid  
4549738369721  
11.00 KD, 130.00 SAR/AED, 125.00 QR, 14.00 BD/OMR  
Approx. W 35 × D 35 × H 32 cm



**Cotton-Linen Polyester Soft**  
Box / L  
4549738369714  
8.50 KD, 105.00 SAR/AED, 100.00 QR, 10.00 BD/OMR  
Approx. W 35 × D 35 × H 32 cm



**Cotton-Linen Polyester Soft**  
Box Cloth Case Large  
4549738369707  
13.00 KD, 135.00 SAR/AED, 130.00 QR, 16.00 BD/OMR  
Approx. W 59 × D 39 × H 23 cm



**Cotton-Linen Polyester Soft**  
Box Cloth Case  
4549738369745  
11.00 KD, 125.00 SAR/AED/QR, 14.00 BD/OMR  
Approx. W 59 × D 39 × H 18 cm



**Cotton-Linen Polyester Soft**  
Box Rectangular / Half / M  
4550002118815  
4.25 KD, 50.00 SAR/AED/QR, 6.00 BD/OMR  
Approx. W 18.5 × D 26 × H 26 cm



**Cotton-Linen Polyester Soft**  
Box Rectangular Box / L  
4550002118822  
11.00 KD, 130.00 SAR/AED/QR, 14.00 BD/OMR  
Approx. W 65 × D 40 × H 26 cm



**Cotton-Linen Polyester Soft**  
Box Rectangular / S / With Zip  
4550002118846  
7.5 KD, 80.00 SAR/AED/QR, 9.5 BD/OMR  
Approx. W 37 × D 26 × H 16 cm



**Cotton-Linen Polyester Soft**  
Box / XS / Half  
4549738369660  
3.00 KD, 35.00 SAR/AED/QR, 4.00 BD/OMR  
Approx. W 13 × D 37 × H 12 cm  
A4



**Cotton-Linen Polyester Soft**  
Box Rectangular / Half / L  
4550002118792  
3.75 KD, 45.00 SAR/AED/QR, 5.00 BD/OMR  
Approx. W 17.5 × D 35 × H 32 cm



**Cotton-Linen Polyester Soft**  
Box Rectangular / Half / L / With Lid  
4550002118785  
5.00 KD, 60.00 SAR/AED/QR, 6.5 BD/OMR  
Approx. W 17.5 × D 35 × H 32 cm



**Cotton-Linen Polyester Soft**  
Box Oblong / S / Half  
4549738369677  
3.25 KD, 40.00 SAR/AED/QR, 4.25 BD/OMR  
Approx. W 18.5 × D 26 × H 16 cm



**Cotton-Linen Polyester Soft**  
Box Square / S  
4549738369684  
6.50 KD, 65.00 SAR/AED, 60.00 QR, 9.00 BD/OMR  
Approx. W 35 × D 35 × H 16 cm



**Cotton-Linen Polyester Soft**  
Box Square / S with Lid  
4549738369691  
7.50 KD, 80.00 SAR/AED, 75.00 QR, 10.00 BD/OMR  
Approx. W 35 × D 35 × H 16 cm



Soft Box / With Zip / Small  
Equipped with partitions, these are handy for organising items that easily lose their shape.

\* Cotton linen polyester storage items are non-washable.



# Polypropylene Storage Unit

There is a wide range of cases, stockers, and boxes.  
Flexibly combine the items and sizes according to your purpose and available space.



A large drawer-type case that fits perfectly into your closet.

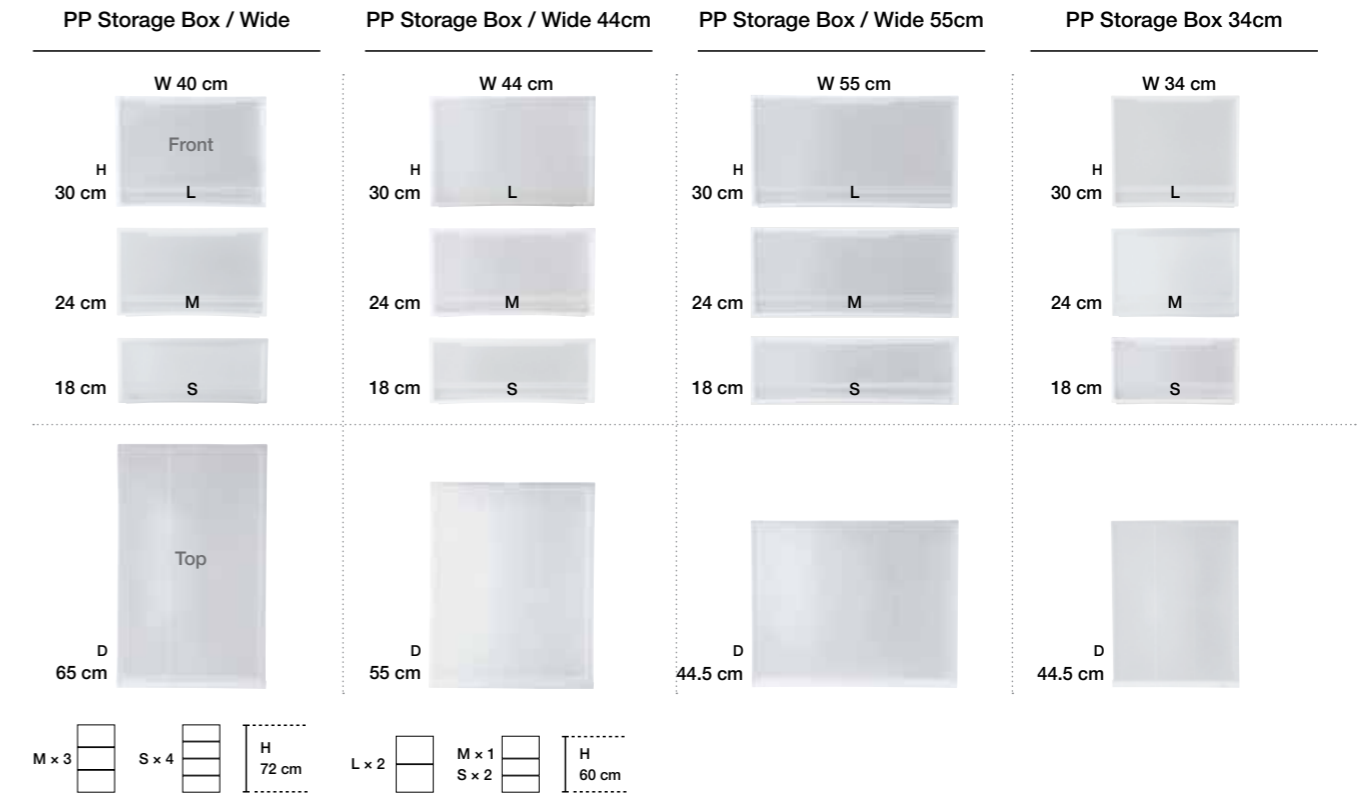

A drawer-type case that can be stacked or fit perfectly into storage furniture.

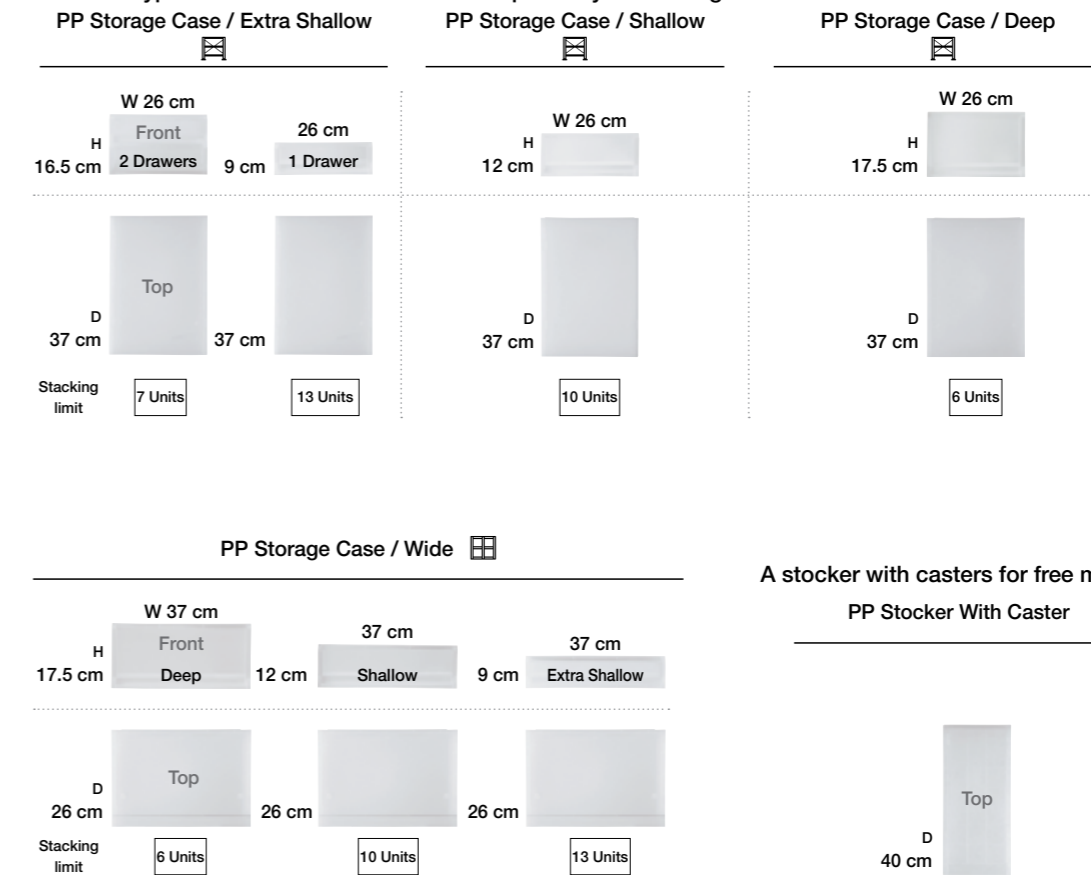

\* To ensure safety, please follow the stacking limit and withstand load requirements.  
\* The polypropylene cases have slight differences in size due to the characteristics of material. When stacked, each case may differ slightly in height.



**PP Storage Case / Extra Shallow / White Grey**

4550002108281  
5.50 KD, 65.00 SAR/AED/QR,  
6.5 BD/OMR  
Approx. W 26 × D 37 × H 9 cm



**PP Storage Case / Shallow / 2 Drawers / White Grey**

4550002108304  
7.50 KD, 95.00 SAR/AED/QR,  
10.00 BD/OMR  
Approx. W 26 × D 37 × H 12 cm



**PP Storage Case Drawer / S**

4547315199686  
7.00 KD, 85.00 SAR/AED,  
80.00 QR, 8.5 BD/OMR  
Approx. W 34 × D 44.5 × H 18 cm



**PP Storage Case Drawer / L**

4547315527021  
8.50 KD, 100.00 SAR/AED,  
95.00 QR, 10.00 BD/OMR  
Approx. W 34 × D 44.5 × H 24 cm



**PP Storage Case Drawer / D**

4547315237005  
9.50 KD, 125.00 SAR/AED,  
115.00 QR, 12.00 BD/OMR  
Approx. W 34 × D 44.5 × H 30 cm



**PP Storage Case / Wide / Extra Shallow / 2 Drawers**

4550002108335  
5.50 KD, 65.00 SAR/AED/QR,  
6.5 BD/OMR  
Approx. W 37 × D 26 × H 9 cm



**PP Storage Case / Wide / Extra Shallow / 2 Drawers**

4550002118990  
7.50 KD, 95.00 SAR/AED/QR,  
10.00 BD/OMR  
Approx. W 37 × D 26 × H 9 cm



**PP Storage Case / Wide / Shallow / White Grey**

4550002108328  
6.50 KD, 80.00 SAR/AED/QR,  
7.5 BD/OMR  
Approx. W 37 × D 26 × H 12 cm



**PP Storage Case Drawer / Wide / S**

4945247266733  
9.50 KD, 125.00 SAR/AED,  
115.00 QR, 12.00 BD/OMR  
Approx. W 55 × D 44.5 × H 18 cm



**PP Storage Case Drawer / Wide / L**

4945247266740  
12.50 KD, 145.00 SAR/AED,  
135.00 QR, 16.00 BD/OMR  
Approx. W 55 × D 44.5 × H 24 cm



**PP Storage Case Drawer / Wide Deep**

4548718182800  
14.00 KD, 170.00 SAR/AED,  
160.00 QR, 17.00 BD/OMR  
Approx. W 55 × D 44.5 × H 30 cm



**PP Storage Case / Wide / Deep / White Grey**

4550002108311  
9.00 KD, 115.00 SAR/AED/QR,  
11.00 BD/OMR  
Approx. W 37 × D 26 × H 17.5 cm



**PP Storage Case Drawer / Wide / M / 3 Row**

4548718510252  
27.00 KD, 335.00 SAR/AED, 315.00 QR, 30.00 BD/OMR  
Approx. W 55 × D 44.5 × H 67.5 cm



**PP Storage Case Drawer / Wide / M / 4 Row**

4548718510269  
30.00 KD, 370.00 SAR/AED,  
350.00 QR, 40.00 BD/OMR  
Approx. W 55 × D 44.5 × H 90 cm



**Polypropylene Storage Case / Extra Shallow (Approx. W 26 × D 37 cm)**



**PP Storage Case / Extra Shallow**

4548076749073 | 2 Drawers  
8.00 KD, 90.00 SAR/AED, 85.00 QR,  
9.00 BD/OMR

Approx. W 26 × D 37 × H 16.5 cm  
Stacking limit: 7 units



4548076749066 | 1 Drawer  
5.50 KD, 65.00 SAR/AED, 60.00 QR,  
6.5 BD/OMR

Approx. W 26 × D 37 × H 9 cm  
Stacking limit: 13 units

Inside dimensions (all items):  
Approx. W 22.5 × D 34 × H 5.5 cm

Withstand load (all items) (with/without casters):  
Approx. 2 kg per drawer, approx. 2 kg on top board

**Polypropylene Storage Case Drawer/Deep (Approx. W 26 × D 37 cm)**



**PP Storage Case Drawer / Deep**

4548076749011 | 1 Drawer  
6.50 KD, 80.00 SAR/AED, 75.00 QR,  
7.5 BD/OMR

Approx. W 26 × D 37 × H 17.5 cm



4547315253586 | 1 Drawers  
6.50 KD, 80.00 SAR/AED/QR, 7.5 BD/OMR  
Approx. W 14 × D 37 × H 17.5 cm

**Polypropylene Storage Case / Deep (Approx. W 26 × D 37 cm)**



**PP Storage Case Drawer / Deep / Partition**

4548076749028 | 2 Drawers (with partition)  
10.00 KD, 125.00 SAR/AED, 115.00 QR,  
12.00 BD/OMR

Approx. W 26 × D 37 × H 17.5 cm

Inside dimensions: Approx. W 10.5 × D 33.5 × H 14 cm

Withstand load (with/without casters): Approx. 2 kg per drawer, approx. 2 kg on top board

4 partitions (movable in 4 steps per drawer in increments of approx. 6 cm)



**PP Storage Case Drawer / Deep / Half**

4548076749035 | 1 Drawer  
5.50 KD, 70.00 SAR/AED, 65.00 QR,  
7.00 BD/OMR

Approx. W 14 × D 37 × H 17.5 cm

**Polypropylene Storage Case / Wide**



**PP Storage Case / Wide / Extra Shallow**

4547315253753  
5.50 KD, 65.00 SAR/AED, 60.00 QR,  
6.5 BD/OMR

W 37 × D 26 × H 9 cm

Inside dimensions:  
Approx. W 34 × D 22.5 × H 5.5 cm

Withstand load (with/without casters):  
Approx. 1 kg per drawer, approx. 5 kg on top board (with reinforcement bar)

Stacking limit: 13 units



4547315253777 | 2 Drawers

7.00 KD, 85.00 SAR/AED, 80.00 QR,  
9.00 BD/OMR

W 37 × D 26 × H 9 cm

Inside dimensions:  
Approx. W 16.5 × D 22.5 × H 5.5 cm

Withstand load (with/without casters):  
Approx. 0.5 kg per drawer, approx. 5 kg on top board (with reinforcement bar)

Stacking limit: 13 units



**PP Storage Case / Wide**

4547315253784 | Shallow  
6.50 KD, 80.00 SAR/AED

W 37 × D 26 × H 12 cm

Inside dimensions:

Approx. W 33.5 × D 22.5 × H 8.5 cm

Withstand load (with/without casters):  
Approx. 1.5 kg per drawer, approx. 5 kg on top board (with reinforcement bar)

Stacking limit: 10 units



4547315253791 | Deep

9.00 KD, 115.00 SAR/AED

W 37 × D 26 × H 17.5 cm

Inside dimensions:

Approx. W 33 × D 22.5 × H 14 cm

Withstand load (with/without casters):  
Approx. 2 kg per drawer, approx. 5 kg on top board (with reinforcement bar)

Stacking limit: 6 units



Please note that above wide drawer-type polypropylene cases cannot be stacked with other drawer-type polypropylene cases.



**Polypropylene Storage Box / Wide Type (Approx. W 40 x D 65 cm)**



**PP Storage Clothes Drawer**  
4547315112081 | D -  
**12.00 KD, 140.00 SAR/AED,  
130.00 QR, 15.00 BD/OMR**

Approx. W 40 x D 65 x H 30 cm  
Inside dimensions:  
Approx. W 33 x D 59 x H 24.5 cm  
Stacking limit: 6 units



4547315112098 | L -  
**9.00 KD, 115.00 SAR/AED,  
105.00 QR, 11.00 BD/OMR**

Approx. W 40 x D 65 x H 24 cm  
Inside dimensions:  
Approx. W 33.5 x D 59 x H 18.5 cm  
Stacking limit: 7 units



4547315112104 | S -  
**7.50 KD, 90.00 SAR/AED, 85.00 QR,  
10.00 BD/OMR**

Approx. W 40 x D 65 x H 18 cm  
Inside dimensions:  
Approx. W 33.5 x D 59.5 x H 12.5 cm  
Stacking limit: 8 units  
Withstand load (all items):  
Approx. 7 kg (with casters:  
approx. 3.5 kg)

**Polypropylene Storage Box / Wide Type (Approx. W 44 x D 55 cm)**



**PP Storage Closet Drawer**  
4547315199693 | D -  
**12.00 KD, 140.00 SAR/AED,  
130.00 QR, 15.00 BD/OMR**

Approx. W 44 x D 55 x H 30 cm  
Inside dimensions:  
Approx. W 38 x D 49.5 x H 24.5 cm  
Stacking limit: 6 units



4547315199709 | L -  
**9.00 KD, 115.00 SAR/AED,  
105.00 QR, 11.00 BD/OMR**

Approx. W 44 x D 55 x H 24 cm  
Inside dimensions:  
Approx. W 38.5 x D 49.5 x H 18.5 cm  
Stacking limit: 7 units



4547315236640 | S -  
**7.50 KD, 90.00 SAR/AED,  
85.00 SAR/AED, 10.00 BD/OMR**

Approx. W 44 x D 55 x H 18 cm  
Inside dimensions:  
Approx. W 38.5 x D 50 x H 12.5 cm  
Stacking limit: 8 units  
Withstand load (all items):  
Approx. 7 kg (with casters: approx. 3.5 kg)

**Polypropylene Storage Case / Drawer / Shallow (Approx. W 26 x D 37 cm)**



**PP Storage Case Drawer / Shallow**  
4548076748977 -  
**6.00 KD, 75.00 SAR/AED,  
70.00 QR, 7.00 BD/OMR**  
Approx. W 26 x D 37 x H 12 cm



4547315253579 - **6.00 KD, 75.00 SAR/AED/QR,  
7.00 BD/OMR**  
Approx. W 55 x D 44.5 x H 24 cm



**Pp Storage Case Drawer / Shallow / 3 Row**  
4548076748991 - **12.00 KD, 140.00 SAR/AED,  
130.00 QR, 15.00 BD/OMR**  
Approx. W 26 x D 37 x H 32.5 cm



**PP Storage Case Drawer / Shallow /3Row /  
Partition**  
4548076749004 - **19.00 KD, 245.00 SAR/AED,  
230.00 QR, 23.00 BD/OMR**  
Approx. W 26 x D 37 x H 32.5 cm



**Pp Storage Case Drawer / Shallow / Half**  
4548076749042 - **5.5.00 KD, 65.00 SAR/AED,  
60.00 QR, 6.5 BD/OMR**  
Approx. W 14 x D 37 x H 12 cm



**Pp Storage Case Drawer / Shallow /Partition**  
4548076748984 - **7.5.00 KD, 95.00 SAR/AED,  
90.00 QR, 10.00 BD/OMR**  
Approx. W 26 x D 37 x H 12 cm

**Polypropylene Trolley & Additional Drawer**



**PP Storage Stoker With Caster 4  
Drawer**  
4547315521821  
**19.00 KD, 245.00 SAR/AED,  
230.00 QR, 23.00 BD/OMR**  
Approx. W 18 x D 40 x H 83 cm  
Inside dimensions:  
(Drawer) approx. W 13 x D 35.5 x  
H 17 cm



**PP Stoker With Caster**  
4547315880195  
**22.00 KD, 270.00 SAR/AED,  
255.00 QR, 27.00 BD/OMR**  
Approx. W 18 x D 40 x H 83 cm  
Inside dimensions:  
(Drawer) approx. W 13 x D 35.5 x  
H 17 cm  
(Deep drawer) approx. W 12.5 x D 35 x  
H 26.5 cm  
(Shallow drawer) approx. W 13 x D 36 x  
H 7 cm



**PP Additional Drawer**  
4547315880171 | Shallow  
**5.00 KD, 60.00 SAR/AED,  
55.00 QR, 6.5 BD/OMR**  
Approx. W 18 x D 40 x H 11 cm  
Inside dimensions: Approx. W 13 x D 36 x  
H 7 cm  
Stacking limit: 10 units  
  
4945247721584  
**5.50 KD, 65.00 SAR/AED,  
60.00 QR, 7.00 BD/OMR**  
Approx. W 18 x D 40 x H 21 cm  
Inside dimensions: Approx. W 13 x D 35.5 x  
H 17 cm  
Stacking limit: 5 units



**PP Storage Stoker With Caster 1**  
4547315880188  
**19.00 KD, 245.00 SAR/AED,  
230.00 QR, 23.00 BD/OMR**  
Approx. W 18 x D 40 x H 83 cm  
  
Inside dimensions:  
(Drawer) approx. W 13 x D 35.5 x  
H 17 cm



**PP Storage Wagon With Caster  
2014**  
4547315253807  
**12.00 KD, 140.00 SAR/AED,  
130.00 QR, 15.00 BD/OMR**  
Approx. W 29 x D 41.5 x H 83 cm

4547315880164 | Deep  
**7.50 KD, 90.00 SAR/AED, 85.00 QR,  
10.00 BD/OMR**  
Approx. W 18 x D 40 x H 30.5 cm  
Inside dimensions: Approx. W 12.5 x D 35 x  
H 26.5 cm  
Stacking limit: 4 units

\* Remove the top board or casters to add additional drawers and create your own original set.

\* Can be stacked up to about 122 cm in height in any combination.



**Caster For PP Storage Case**

4547315523788 | Set of 4  
**3.00 KD, 35.00 SAR/AED,  
30.00 QR, 3.00 BD/OMR**

Approx. W 3.5 x D 3.5 x H 6 cm  
These casters can be easily attached to the bottom of the following polypropylene cases by inserting the connectors into the holes.

\* Using the casters increases the total height by approx. 3.8 to 4.2 cm (exact height-increase depends on the case used).

\* Do not use casters on tatami, cushion floors, or other soft flooring in order to prevent damage to the floor.

⚠ Please note the set cannot be disassembled again once it has been put together.



# Furniture

## Oak & Walnut



### Oak

Used for furniture and floorboards for many years, oak which is hard, solid and durable is a perfect material for long-lasting furniture. The delicate and soft expression creates furniture with a mellow impression.

Patterns called "tiger grain" which resemble the pattern of tiger stripes and its delicate and gentle grain are characteristics of oak. The look of oak is enhanced as the material ages over time.



### Walnut

Walnut is a well-known wood material that has been used for furniture since olden times and is still used today for high-end furniture and crafts. It features a beautiful surface and little warping.

Ageing of the wood can be enjoyed as the wood contains a moderate amount of oil which provides glossiness and allows the wood to age well. Walnut is treasured as one of the world's three major wood types together with teak and mahogany.





# Stacking Shelves

Free to be used horizontally or vertically, stacking shelves are a strong and attractive storage solution. A large number of our storage products will fit into stacking shelves, for the ultimate modular storage solution. Stacking shelves use metal rods inside and are available in both oak and walnut colour.



## Basic configuration of stacking shelf

The units can be easily linked by connecting the steel pipes inside the dividers and fastening them with the bolts. MUJI's storage items fit nicely in these shelves. Original storage furniture can be freely created by combining a basic set with additional sets.

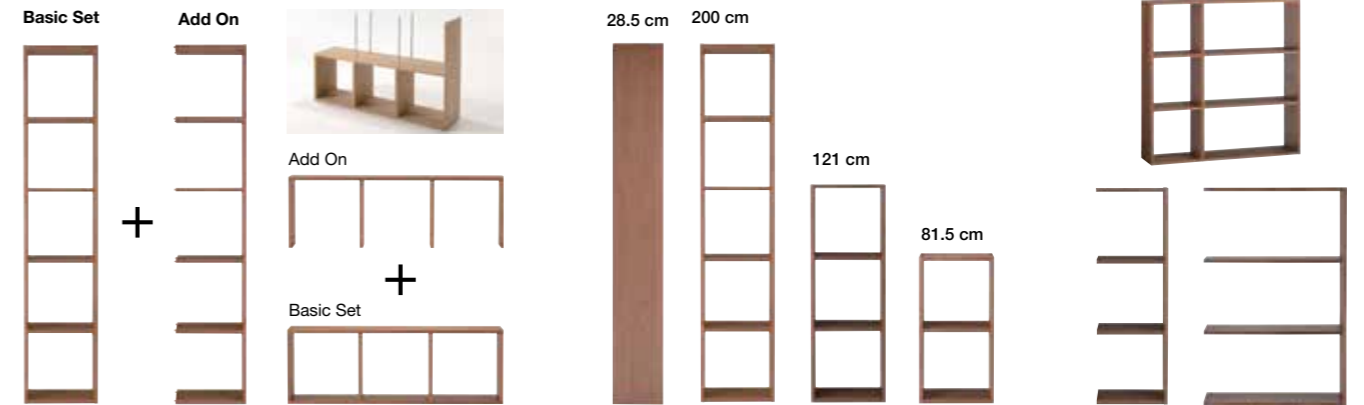

By combining a basic set with additional sets, you can extend the shelves vertically and horizontally to achieve your desired configuration.

This item is only available in depth 28.5 cm. You can choose from three heights.

**Example:** You can choose from two block widths.

### Stacking mechanism

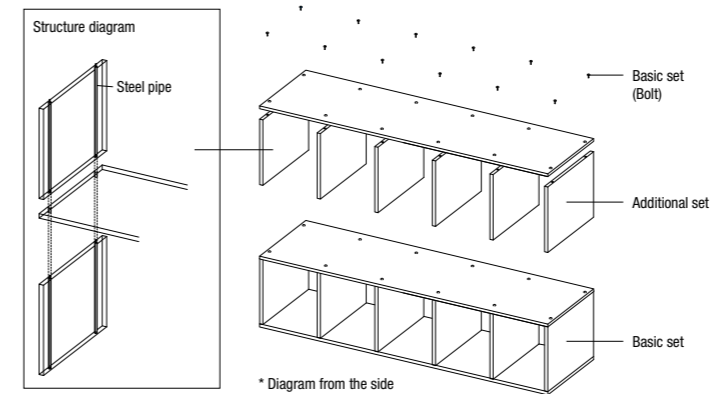

### Example of Usage

#### Combination of differing tiers

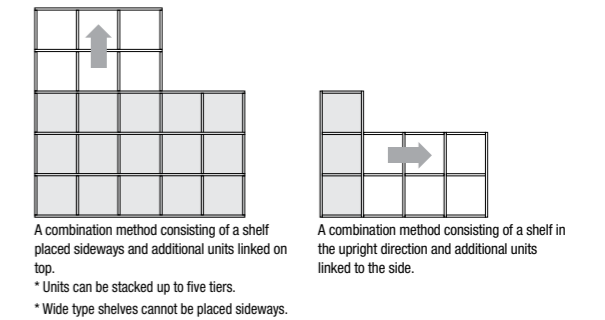

#### Example of combination and withstand load

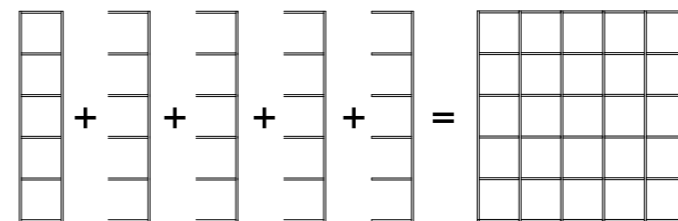

Narrow 5 shelf x 1 + Narrow 5 shelf Add On x 4

A combination method consisting of a shelf in the upright direction and additional units linked to the side.

Withstand load: 150 kg total = 60 kg x 5 units ÷ 2

Total withstand load when shelves are combined = Withstand load of set x number of units ÷ 2

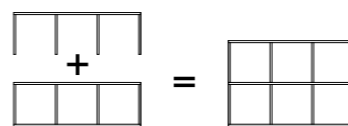

Narrow 3 shelf x 1 + Narrow 3 shelf Add On x 1

A combination method consisting of a shelf placed sideways and additional units linked on top.

Withstand load: 40 kg total = 40 kg x 2 units ÷ 2

Total withstand load when shelves are combined = Withstand load of set x number of units ÷ 2

#### Combination of items with differing widths

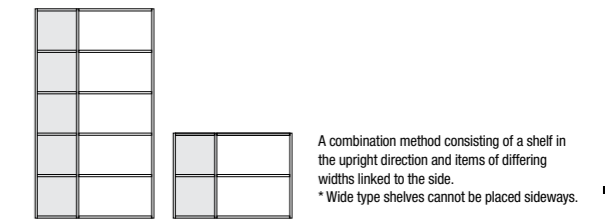

A combination method consisting of a shelf in the upright direction and items of differing widths linked to the side.

\* Wide type shelves cannot be placed sideways.

#### Using as a partition

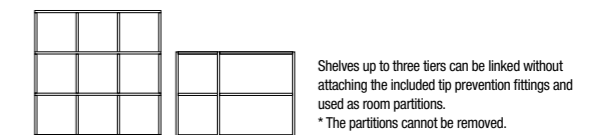

Shelves up to three tiers can be linked without attaching the included tip prevention fittings and used as room partitions.

\* The partitions cannot be removed.



**Basic Set** The basic set comes in three types: 5 shelf, 3 shelf and 2 shelf, and two widths.

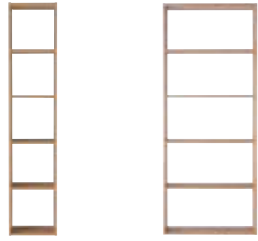

5 Shelf  
W 42 x H 200 cm    W 81.5 x H 200 cm



3 Shelf  
W 42 x H 121 cm    W 81.5 x H 121 cm



2 Shelf  
W 42 x H 81.5 cm    W 81.5 x H 81.5 cm

\* Depth for all types is 28.5 cm

Narrow 5 Shelves	Narrow 3 Shelves	Narrow 2 Shelves
105.00 KD, 1,250.00 SAR/AED/QR, 129.00 BD/OMR	85.00 KD, 1,050.00 SAR/AED/QR, 105 BD/OMR	69.00 KD, 950.00 SAR/AED/QR, 85 BD/OMR
4549738932116   Oak - 4549738932314   Walnut	4549738932109   Oak 4549738932307   Walnut	4549738932093   Oak 4549738932291   Walnut
Wide 5 Shelves	Wide 3 Shelves	Wide 2 Shelves
135.00 KD, 1,750.00 SAR/AED/QR, 165.00 BD/OMR	109.00 KD, 1,350.00 SAR/AED/QR, 135.00 BD/OMR	95.00 KD, 1,150.00 SAR/AED/QR, 115.00 BD/OMR
4549738932178   Oak 4549738932376   Walnut	4549738932161   Oak 4549738932369   Walnut	4549738932154   Oak 4549738932352   Walnut

**Add On** By combining a basic set with additional sets, you can extend the shelves vertically and horizontally.

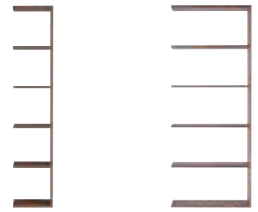

5 Shelf  
W 40 x H 200 cm    W 79.5 x H 200 cm



3 Shelf  
W 40 x H 121 cm    W 79.5 x H 121 cm



2 Shelf  
W 40 x H 81.5 cm    W 79.5 x H 81.5 cm

\* Depth for all types is 28.5 cm

Narrow 5 Shelves (Add On)	Narrow 3 Shelves (Add On)	Narrow 2 Shelves (Add On)
95.00 KD, 1,150.00 SAR/AED/QR, 115.00 BD/OMR	79.00 KD, 950.00 SAR/AED/QR, 95.00 BD/OMR	65.00 KD, 850.00 SAR/AED/QR, 79.00 BD/OMR
4549337263208   Oak 4549337265677   Walnut	4549337263192   Oak 4549337265660   Walnut	4549337263185   Oak 4549337265653   Walnut
Wide 5 Shelves (Add On)	Wide 3 Shelves (Add On)	Wide 2 Shelves (Add On)
125.00 KD, 1,550.00 SAR/AED/QR, 155.00 BD/OMR	105.00 KD, 1,250.00 SAR/AED/QR, 125.00 BD/OMR	89.00 KD, 1,050.00 SAR/AED/QR, 110.00 BD/OMR
4549337263260   Oak 4549337265738   Walnut	4549337263253   Oak 4549337265721   Walnut	4549337263246   Oak 4549337265714   Walnut

**Optional Parts for Stacking Shelf** This item can be used by itself or in combination with a stacking shelf.



**1 x 2 Drawer Set**  
45.00 KD, 550.00 SAR/AED/QR,  
55.00 BD/OMR  
4550002554057 | Oak  
4550002554088 | Walnut  
W 37 x D 28 x H 37 cm  
**Withstand load:** Top board 5 kg, each  
drawer 3 kg, total 5 kg  
**Inside dimensions of drawer:** W 33.5  
x D 24.5 x H 15.5 cm



**1 x 4 Drawer Set**  
45.00 KD, 550.00 SAR/AED/QR,  
55.00 BD/OMR  
4550002554071 | Oak  
4550002554101 | Walnut  
W 37 x D 28 x H 37 cm  
**Withstand load:** Top board 5 kg, each  
drawer 2 kg, total 5 kg  
**Inside dimensions of drawer:** W 33.5 x  
D 24.5 x H 6 cm



**2 x 2 Drawer Set**  
45.00 KD, 550.00 SAR/AED/QR,  
55.00 BD/OMR  
4550002554064 | Oak  
4550002554095 | Walnut  
W 37 x D 28 x H 37 cm  
**Withstand load:** Top board 5 kg,  
each drawer 2 kg, total 5 kg  
**Inside dimensions of drawer:** W 15  
x D 24.5 x H 15.5 cm

\* The material used inside the drawers (MDF) may have a distinct smell. Although the smell will fade with use, it is recommended to avoid storing clothing or other items that can absorb odour inside the drawers.



**1 x 2 Drawer Set**  
25.00 KD, 300.00 SAR/AED/QR,  
30.00 BD/OMR  
4550002528515 | Oak  
4550002528522 | Walnut  
W 37 x D 28 x H 1 8.5cm



**1 x 2 Drawer Set**  
25.00 KD, 300.00 SAR/AED/QR,  
30.00 BD/OMR  
4550002528706 | Oak  
4550002528713 | Walnut  
W 37 x D 28 x H 18.5cm





## Dining

Made with North American natural wood which ages well over time.



### Tables:



Natural Oak Table (With Drawer) / W 180 cm

4550182009330 - 289.00 KD, 2,999.00 SAR/AED/QR, 375.00 BD/OMR

W 180 x D 80 x H 72 cm



Natural Oak Table (With Drawer) W 140 cm

4550182009323 - 259.00 KD, 2,699.00 SAR/AED/QR, 335.00 BD/OMR

W 140 x D 80 x H 72 cm



Natural Walnut Table (With Drawer) / W 180 cm

4550182049480 - 289.00 KD, 2,999.00 SAR/AED/QR, 375.00 BD/OMR

W 180 x D 80 x H 72 cm



Natural Walnut Table (With Drawer) / W 140 cm

4550182049473 - 259.00 KD, 2,699.00 SAR/AED/QR, 335.00 BD/OMR

W 140 x D 80 x H 72 cm



Bench / Wooden Seat

4547315892334 | Walnut - 125.00 KD, 1,550.00 SAR/AED, 1500 QR, 155.00 BD/OMR

W 100 x D 37 x H 44 cm

Inside dimensions of storage compartment:

W 91 x D 20 x H 11 cm



Table Bench / Wooden Seat

4547315892419 | Oak - 125.00 KD, 1,550.00 SAR/AED, 1500 QR, 155.00 BD/OMR

W 100 x D 37 x H 44 cm

Inside dimensions of storage compartment:

W 91 x D 20 x H 11 cm



Bench Shelf

4547315892426 | Oak - 160.00 KD, 2,090.00 SAR/AED, 2000.00 QR, 200.00 BD/OMR

W 120 x D 37.5 x H 44 cm

Inside dimensions of storage compartment:

W 115 x D 37.5 x H 33 cm

A good height to use even as a low table and enough strength for use as a bench. The space under the seat can be used as a storage space.



Bench Shelf

4547315967476 | Walnut - 160.00 KD, 2,090.00 SAR/AED, 2000.00 QR, 200.00 BD/OMR

W 120 x D 37.5 x H 44 cm

Inside dimensions of storage compartment:

W 115 x D 37.5 x H 33 cm

A good height to use even as a low table and enough strength for use as a bench. The space under the seat can be used as a storage space.



**Table Round Legs / Oval**  
4547315901999 | Natural Oak  
390.00 KD, 4,900.00 SAR/AED,  
4950 QR, 480.00 BD/OMR  
W 180 × D 80 × H 72 cm



**Bench Round Legs**  
4550002065959 | Oak  
150.00 KD, 1,750.00 SAR/AED/QR,  
180.00 BD/OMR  
W 100 × D 35 × H 44 cm



**Stool Round Legs**  
4550002065966 | Oak  
100.00 KD, 1,200.00 SAR/AED/QR,  
125.00 BD/OMR  
W 55 × D 32 × H 74 cm



**Bench / S**  
4547315892365 | Oak  
35.00 KD, 450.00 SAR/AED,  
425.00 QR, 43.00 BD/OMR  
W 45 × D 30 × H 44 cm



**Bench / L**  
4547315892358 | Oak  
40.00 KD, 500.00 SAR/AED,  
475.00 QR, 48.00 BD/OMR  
W 100 × D 30 × H 44 cm



**Oak Desk**  
4934761361901 | Oak  
99.00 KD, 1,850.00 SAR/AED/QR,  
170.00 BD/OMR  
W 110 × D 52 × H 70 cm  
Laminated natural oak  
Design considers placement of  
cables when using a computer.  
The holder can be attached on the  
right, left side or in the centre of  
the rear beam.



**Cabinet**  
4934761361925 |  
Oak  
69.00 KD,  
1,350.00 SAR/  
AED/QR, 125.00  
BD/OMR  
W 37.5 × D 40.5  
× H 58.5 cm



## Chair

We have prepared chairs made of different materials and types of comfort to match a variety of tables.



**Round Chair**  
4550182009255 | Oak  
65.00 KD, 750.00 SAR/AED/QR,  
65.00 BD/OMR  
W 45 × D 51 × H 77 (seat surface: 42) cm

This chair was created with a focus on comfort. The rounded back and seat will fit comfortably around the body. The back rest is made wide and tall and is curved to allow the body to fit in. The seat is also wide and curved, realising a comfortable fit.



**Arm Chair Round Legs**  
4547315902040 | Oak  
165.00 KD, 2,000.00 SAR/AED/QR,  
205.00 BD/OMR  
W 55 × D 32 × H 74 (seat surface: 42) cm



**Walnut Chair**  
4547315967469 | Cotton Plain Weave / Beige  
Main body: Walnut  
52.00 KD, 690.00 SAR/AED,  
650.00 QR, 65.00 BD/OMR  
W 38 × D 48.5 × H 79 (seat surface: 45.5) cm



**Oak Chair**  
4547315892372 | Cotton Plain Weave / Beige  
Main body: laminated natural oak  
52.00 KD, 690.00 SAR/AED,  
650.00 QR, 65.00 BD/OMR  
W 38 × D 48.5 × H 79 (seat surface: 45.5) cm



### The timeless basic design is ideal for desks.

You can add components and modify usage to suit your child's growth and development. One of the charms of natural wood is that it changes colour with age. You can create functional, compact and easy-to-clean desk spaces by combining the desk with storage furniture of the same material.



# Living Room



## Sofa

A sofa in a simple shape.  
Parts can be replaced which enables use over many years.



### Sofa / Urethane / Pocket Coil / Left

4550182011449 | 3 seater + 8 Legs / H 10 cm  
330.00 KD/BD/OMR, 4,000.00 SAR/AED/QR  
W 225.5 x D 150 x H 80 cm (with Legs/H 10 cm attached)



### Sofa / Urethane / Pocket Coil / Right

4550182011456 | 3 seater + 8 Legs / H 10 cm  
330.00 KD/BD/OMR, 4,000.00 SAR/AED/QR  
W 225.5 x D 150 x H 80 cm (with Legs/H 10 cm attached)



### SOFA / FEATHER / POCKET COIL / OTTOMAN / L

4550182008098 | + Legs / H 10 cm  
65.00 KD/BD/OMR, 750.00 SAR/AED/QR  
W 77 x D 54.5 x H 40 cm (with Legs/H 10 cm attached)



### SOFA / WIDE ARM / FEATHER / POCKET COIL

4550182011425 | 3 seater + 8 Legs / H 10 cm  
270.00 KD/BD/OMR, 3,250.00 SAR/AED/QR  
W 225.5 x D 88 x H 80 cm (with Legs/H 10 cm attached)

## Common leg types



### Wooden Leg

4550002528867 / Natural  
10.00 KD, 100.00 SAR/AED/QR, 14.00 BD/OMR  
H 10 cm  
M8 dia. 6 cm / set of 4

Main unit		Cover	
		Plain Weave Cotton	Beige
Sofa cover / 3S 125.00 KD, 1,500.00 SAR/AED/QR, 155.00 BD/OMR Ottoman: 32.00 KD/BD/OMR, 400.00 SAR/AED/QR	Type Left	Cotton Polyester	4550182074338
	Type Right	Cotton Polyester	4550182074321
	Wide Arm	Cotton Polyester	4550182074239
	Ottoman	Cotton Polyester	4550182074307



## Unit Sofa

Sofa modules that can be mixed and matched to fit your lifestyle.



**Unit Sofa / Armless / L**

4550002527990

150.00 KD, 1,800.00 SAR/AED/QR,  
195.00 BD/OMR

W 77 × D 98 × H 66 cm



**Unit Sofa / With Arms / L**

4550002527983

180.00 KD, 2,200.00 SAR/AED/QR,  
235.00 BD/OMR

W 98 × D 98 × H 66 cm



**Unit Sofa / Ottoman / L**

4550002528003

89.00 KD, 1,100.00 SAR/AED/QR,  
120.00 BD/OMR

W 77 × D 77 × H 37 cm



**Unit Sofa Cushion**



4549738666349

13.00 KD, 150.00 SAR/AED/QR, 17.00 BD/OMR

W 61 × D 16 × H 13 cm



### Unit Sofa cover chart

			Cover	
			Plain Weave Cotton	
				
			Beige	Dark Brown
Main unit				
	Cushion	Cotton Polyester	4550002884932 W 77 cm	4550002884949 W 77 cm
	Armless	Cotton Polyester	4550002884895 W 77 cm	4550002884901 W 77 cm
	With Armset	Cotton Polyester	4550002884871 W 98 cm	4550002884888 W 98 cm
Ottoman	Cotton Polyester	4550002884918 W 77 cm	4550002884925 W 77 cm	

These sofas are carefully designed for seating comfort and can be freely combined into a variety of configurations.



The seat cushions are constructed from a concave moulded urethane base topped with a bag filled with crushed urethane foam, for plush seating comfort.

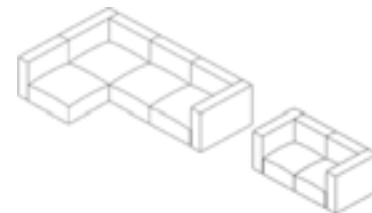

The units can be combined to create a sofa set for a large living room, or they can be used individually as a compact sofa. You can freely select the combination that best suits your lifestyle and living space.

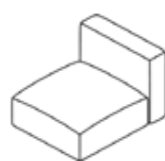
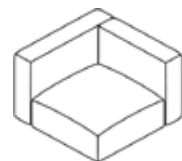

Whether your preference is to use a single module as a roomy seat for one person, or combine multiple modules to use as a complete sofa, you can select a combination that fits your living environment.





# Beads Sofa

The beads sofa changes its shape freely to fit your leisure position. Filled with micro particle beads, the sofa wraps around you for comfortable sitting. You can enjoy different seating comfort depending on how the sofa is placed.



### Beads Sofa

4934761049182

60.00 KD, 750.00 SAR/AED/QR, 70.00 BD/OMR

W 65 x D 65 x H 43 cm

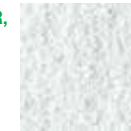

The micro particle beads maintain its shape and create an extremely soft feel.

### Cover for Beads Sofa

15.00 KD, 200.00 SAR/AED/QR, 19.00 BD/OMR

1- 4549337287594 - Charcoal Grey

4- 4548076580294 - Navy

2- 4550002527907 - Heather Grey

5- 4549337100619 - Navy Denim

3- 4934761048888 - Beige

6- 4934761048871 - Dark Brown

### Sitting on a "vertically placed" sofa

The sofa wraps around the lower back and neck to support any posture that one wishes to relax in. Perfect when reading or watching TV.

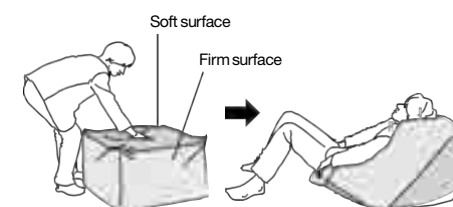

### Sitting on a "horizontally placed" sofa

The sofa spreads in a circular manner to allow the body to sink in deeply and be supported. Perfect for taking a nap.

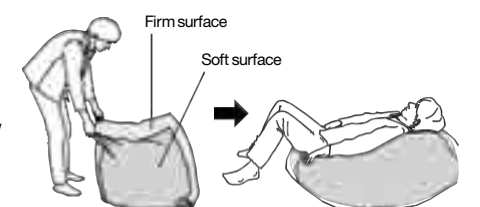

-During the course of use, the beads may settle and cause a slight variance in thickness.

-The Beads Sofa cannot be washed.

-Slight shrinking of the cover may occur by dry cleaning.

-The sofa cannot be used alone. Be sure to use it with a cover.

## Floor Chair

This simple floor chair matches any kind of room.  
A legless chair with covering. With 6-step reclining function.



**Floor Chair (body)**  
4548718481286 | L  
21.00 KD, 300.00 SAR/AED/QR, 27.00 BD/OMR  
W 57 x D 102 x H 10cm

### Cotton Canvas Cover For Floor Chair

12.00 KD, 100.00 SAR/AED, 75.00 QR, 14.00 BD/OMR

4549337746886 - Ecu  
100% cotton



4547315999699 - Dark Brown  
100% cotton



4547315999057 - Beige  
100% cotton [Dry cleaning only]\*

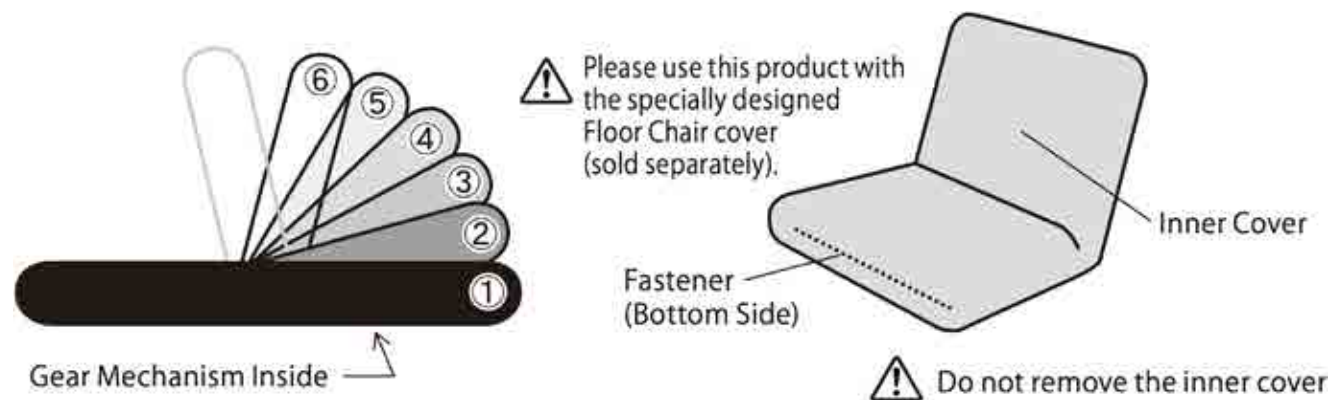

## High Back Reclining Sofa

Relax in MUJI's High Back Reclining Sofa. It comes with an adjustable headrest that can be adjusted manually to 6 levels (including flat level).  
With optimum durability and comfort from top to bottom, the wooden legs now come in Oak Wood and rounded edges.



**High Back Reclining Sofa**  
4550002405236 | 1S  
139.00 KD, 1,749.00 SAR/AED/QR,  
180.00 BD/OMR  
W 98 x D 98 x H 66 cm



**Ottoman**  
4550002405113  
50.00 KD, 650.00 SAR/AED/QR,  
70.00 BD/OMR  
W 98 x D 98 x H 66 cm



### Sofa cover chart

		Cover	
		Beige	Brown
Main unit	Sofa	Cotton Polyester 4550002884512	Cotton Polyester 4550002884529
	Ottoman	Cotton Polyester 4550002884536	Cotton Polyester 4550002884543





# Bedroom

Beds, mattresses, pillows & duvets.



## Wooden Beds

Find your ideal bed with a range of styles that are designed to be practical, comfortable, and elegant.

### Your original bed frame

MUJI's bed frame was born from feedback from customers seeking an infinite variety of characteristics in beds. By combining the frame with the optional components such as legs, headboard, mattress and underbed storage, you can customise the bed to suit your living style and your desired sleeping comfort.

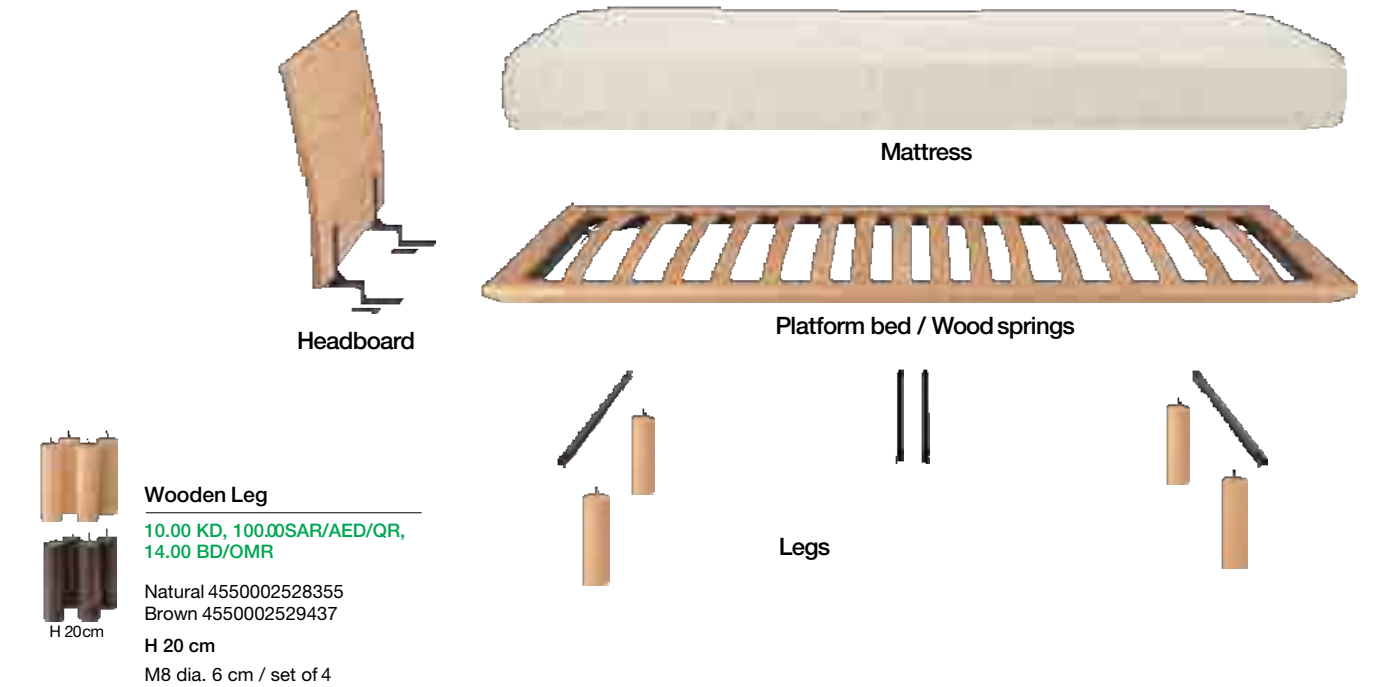

\* Example combination: mattress is sold separately.

#### Bed Frame / Headboard / Oak

4550002850647 | Double W 147 × D 8 × H 53 cm  
**75.00 KD, 1,000.00 SAR/AED, 950.00 QR, 95.00 BD/OMR**  
 4550002855468 | Queen W 171 × D 8 × H 53 cm

4550002855444 | King W 182 × D 8 × H 53 cm  
**90.00 KD, 1,200.00 SAR/AED, 1,100 QR, 110.00 BD/OMR**



#### Bed Frame / Main Unit / Oak

4550002527853 | Double -  
**175.00 KD, 2,300 SAR/AED, 2,200.00 QR, 221.00 BD/OMR**  
 4550002527877 | King -  
**215.00 KD, 2,600 SAR/AED, 2,550.00 QR, 276.00 BD/OMR**  
 4550002527860 | Queen -



\* Example combination: mattress is sold separately.

#### Bed Frame / Headboard / Walnut

4550002850685 | Double W 147 × D 8 × H 53 cm  
**75.00 KD, 1,000.00 SAR/AED, 950.00 QR, 95.00 BD/OMR**  
 4550002855475 | Queen W 171 × D 8 × H 53 cm

4550002855451 | King W 182 × D 8 × H 53 cm  
**90.00 KD, 1,200.00 SAR/AED, 1,100 QR, 110.00 BD/OMR**



#### Bed Frame / Main Unit / Walnut

4550002528973 | Double -  
**175.00 KD, 2,300.00 SAR/AED, 2,200.00 QR, 221.00 BD/OMR**  
 4550002528997 | King -  
**215.00 KD, 2,600 SAR/AED, 2,550.00 QR, 276.00 BD/OMR**  
 4550002528980 | Queen

## Storage Bed

This single bed features a storage space equal to that of two wide 4-drawer chests. Store everything from daily-use clothing to suitcases and comforters.



### Example storage

Example storage under a Double bed



**Open space**  
A storage space is also provided behind the drawer space. In the space under Double size, you can store long or large objects, such as rugs, skis, duvets, and carry cases.  
\* Bottom board is not provided under the open space.



Ventilation holes are made below the open space to allow moisture to escape.

**Drawers**  
In the drawers, available for all sizes of beds, you can store daily-use clothing and beddings.



Bed board is made of wood slats that reduce the dust getting into the storage compartment.



\* Example combination: mattress is sold separately.

### Storage Bed Headboard / Oak

4549337497863 | Double  
75.00 KD, 1,000.00 SAR/AED, 950.00 QR, 95.00 BD/OMR  
4549738371304 | Queen  
80.00 KD, 1,100.00 SAR/AED, 1,000.00 QR, 100.00 BD/OMR  
4549738371311 | King  
90.00 KD, 1,200.00 SAR/AED, 1,100.00 QR, 110.00 BD/OMR



\* Example combination: mattress is sold separately.

### Storage Bed Headboard / Walnut

4549337497900 | Double  
75.00 KD, 1,000.00 SAR/AED, 950.00 QR, 95.00 BD/OMR  
4549738371328 | Queen  
80.00 KD, 1,100.00 SAR/AED, 1,000.00 QR, 100.00 BD/OMR  
4549738371335 | King  
90.00 KD, 1,200.00 SAR/AED, 1,100.00 QR, 110.00 BD/OMR

## Mattress

Independent barrel-shaped springs have been individually wrapped with non-woven fabric so that each coil moves separately to enable the best hardness for sleeping position..

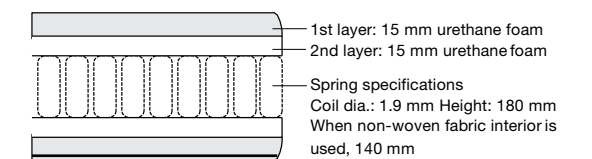

### Pocketcoil Spring Mattress

4548718094868 | Double W 140 x D 195 x t 19 cm  
250.00 KD, 3,250.00 SAR/AED/QR, 325.00 BD/OMR  
4934761863351 | Queen W 160 x D 195 x t 19 cm  
300.00 KD, 3,950.00 SAR/AED/QR, 395.00 BD/OMR  
4934761854182 | King W 180 x D 195 x t 19 cm  
350.00 KD, 4,550.00 SAR/AED/QR, 465.00 BD/OMR



\* Example combination: mattress is sold separately.

### Storage Bed / Oak

4549337407961 | Double W 147 x D 201 x H 27 cm  
185.00 KD, 2,400.00 SAR/AED, 2,300.00 QR, 235.00 BD/OMR  
4549738371229 | Queen W 168.5 x D 201 x H 27 cm  
210.00 KD, 2,550.00 SAR/AED, 2,500.00 QR, 250.00 BD/OMR  
4549738371236 | King W 188.5 x D 201 x H 27 cm  
225.00 KD, 2,700.00 SAR/AED, 2,650.00 QR, 290.00 BD/OMR



\* Example combination: mattress is sold separately.

### Storage Bed / Oak

4549337408005 | Double W 147 x D 201 x H 27 cm  
185.00 KD, 2,400.00 SAR/AED, 2,300.00 QR, 235.00 BD/OMR  
4549738371243 | Queen W 168.5 x D 201 x H 27 cm  
210.00 KD, 2,550.00 SAR/AED, 2,500.00 QR, 250.00 BD/OMR  
4549738371250 | King W 188.5 x D 201 x H 27 cm  
225.00 KD, 2,700.00 SAR/AED, 2,650.00 QR, 290.00 BD/OMR

\* Due to the nature of the material, oak may have a unique pattern called "tiger grain."  
\* The characteristics of natural wood, such as the colour and grain pattern, may vary in appearance depending on the material.



## Pillow

The "pillow" is an essential part of sleep that accounts for one third of each day. Choose a pillow to your liking from different materials, firmness, and elasticity.



### Feather Pillow

4549738756200 | 43 × 63 cm  
6.00KD ,70.00 AED/SAR/QR , 8.00 BD/OMR

4549738756217 | 50 × 70 cm  
7.50KD ,95.00 AED/SAR, 80.00 QR, 9.500 BD/OMR

Outer shell: 100% cotton, down-proofed finish. Inner shell: 100% polyester  
Filling: 100% waterfowl feathers. [Dry-cleaning only (using a petroleum-based detergent)]

This pillow uses waterfowl feathers which are light and maintain volume. This pillow is characterised by the comfort of a soft enveloping feel around the back of the head.



### Polyester Pillow

4550002832155 | 43 × 63 cm  
10.00KD ,120.00 AED/SAR/QR , 14.00 BD/OMR

Outer shell: 65% polyester, 35% cotton Stuffing: 100% polyester [Non-washable]

This item uses hollow polyester wadding for the stuffing, which has a light and soft feel. It is fluffy and comfortable to use.



### Urethane Foam Low Repulsion Chip Pillow

4549337750364 | 43 × 63 cm  
8.00KD ,100.00 AED/SAR/QR , 22.00 BD/OMR

Outer shell: 57% polyester, 43% cotton  
Stuffing: Urethane foam [Non-washable]

Slow-sinking low-rebounding urethane has been mixed at a perfect blend with high-rebounding urethane having moderate elasticity.



### Down Blend Pillow

4549738994411 | 43 × 63 cm  
25.00KD ,320.00 AED/SAR, 300.00 QR, 30 BD/OMR

4549738994428 | 50 × 70 cm  
30.00KD ,420.00 AED/SAR , 400.00 QR, 35 BD/OMR

## Duvet

Duvets designed with consideration of materials and functionality for a comfortable sleep.



### Gray Down Duvet One Layer

4550182049589 | 190 × 210 cm  
cm 99.00KD ,1250.00 AED/SAR/QR, 120 BD/QMR

4550182049602 | 230 × 210 cm  
119.00KD ,1500.00 AED/SAR/QR,140 BD/OMR

4550182049596 | 210 × 210 cm  
139.00KD ,1750.00 AED/SAR/QR, 160 BD/OMR

Outer shell: 100% polyester, down-proofed finish

Filling: 80% down, 20% feather

Fill power: 350

Using free ranged, humanely raised gray duck feathers, we have created this lightweight and compact duvet.



### Difference between down and feathers



#### Down

Light, soft, and heat retaining feathers which look like the fluff of a dandelion mostly found around the chest and stomach of waterfowls.



#### Feather

The portion which is commonly referred to as a feather which has a curved shaft and elasticity.



### Natural grey colour

Many grey geese are found in quiet rural areas of Ukraine. Though domesticated long ago, the grey goose retains the dark colour reminiscent of wild migratory geese. The birds roam freely in a natural environment. When fully grown, the grey goose is bigger than a duck and has excellent mobility. The warm and strong feathers of the grey goose are ideal for duvets.



The geese on the farm are fed corn in the morning and after that, they eat naturally growing grass and insects.



Families of geese congregate on nearby lakes and rivers in early spring.



The geese return to the farm in the evening.

## Tableware





## Acacia

MUJI Acacia serving ware is made in the Philippines. Acacia trees grow more than 50cm in diameter; so just one single tree yields a huge amount of wood. Hollowing out the tree takes a great deal of skill and is carried out by expert local craftspeople.

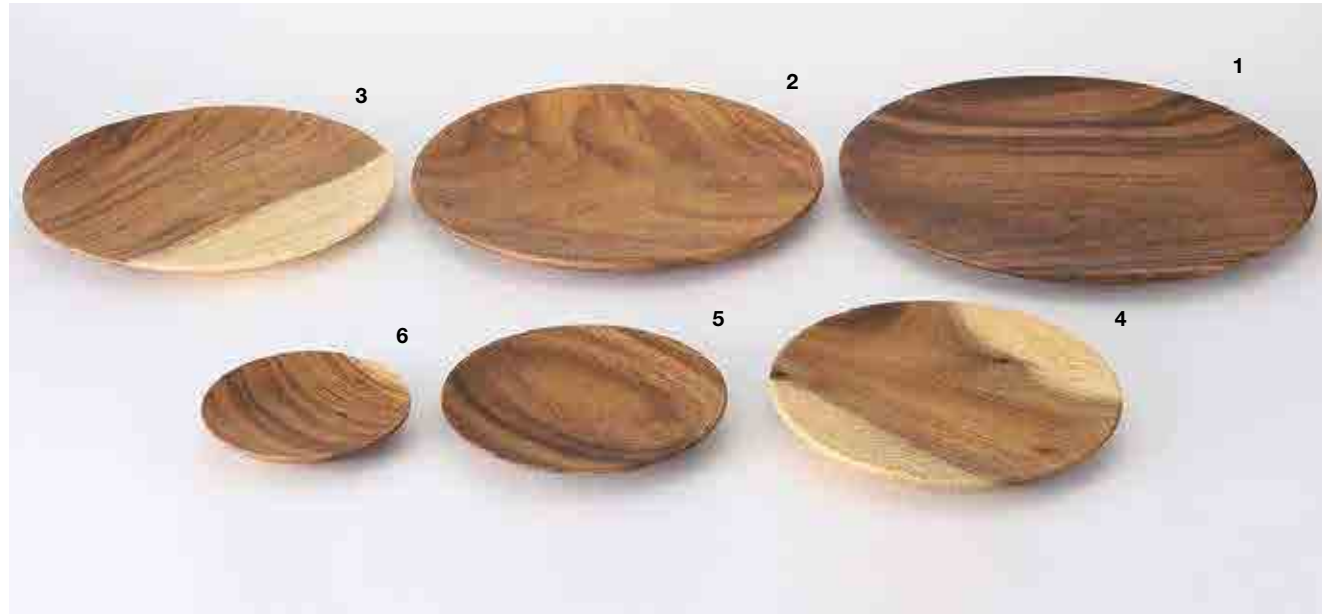

### Acacia Plate

1-4549337083578   7.50KD , 80.00 AED/SAR 75.00 QR ,9.50 BD/OMR	Approx.dia. 30 × H 2.5 cm	3-4549337083585   6.5.00KD , 75.00 AED/SAR 70.00 QR ,8.00 BD/OMR	Approx.dia. 23 × H 2 cm	5-4549337083677   3.50KD , 40.00 AED/SAR 35.00 QR ,4.00 BD/OMR	Approx.dia. 15 × H 2 cm
2- 4549337185272   7.00KD , 85.00 AED/SAR 80.00 QR , 8.50 BD/OMR	Approx.dia. 26 × H 2 cm	4-4549337083660   4.50KD , 55.00 AED/SAR 50.00 QR ,6.00 BD/OMR	Approx.dia. 19 × H 2 cm	6-4549337083684   2.00KD , 30.00 AED/SAR 25.00 QR ,3.00 BD/OMR	Approx.dia. 11 × H 2 cm

### Acacia Tray

1-4550002882907	Approx.dia. 32 cm	8.00KD ,90.00 AED/SAR/QR 9.00 BD/OMR
2- 4550002882914	Approx.dia. 26cm	6.50KD ,80.00 AED/SAR/QR 8.50 BD/OMR



### Acacia Trivet

1-4550002882921	Approx.dia. 20 cm	3.75KD ,45.00 AED/SAR/QR , 5.00BD/OMR
-----------------	-------------------	---------------------------------------



### Acacia Bowl

1-4549337082724   21.00KD , 255.00 AED/SAR 250 QR , 27.00 BD/OMR	Approx.dia. 30 × H 10 cm	4-4549337083264   6.00KD , 70.00 AED/SAR 65 QR , 8.00 BD/OMR	Approx.dia. 16 × H 7 cm	6-4549337083288   3.5.00KD , 40.00 AED/SAR 35 QR , 4.00 BD/OMR	Approx.dia. 10 × H 5 cm
2-4549337082731   11.00KD , 115.00 AED/SAR 110 QR , 14.00 BD/OMR	Approx.dia. 24 × H 9 cm	5-4549337083271   4.00KD , 50.00 AED/SAR 45 QR , 5.00 BD/OMR	Approx.dia. 13 × H 6 cm	7-4549337083325   2.00KD , 20.00 AED/SAR 15 QR , 2.50 BD/OMR	Approx.dia. 8 × H 4.5 cm
3-4549337082748   8.00KD , 90.00 AED/SAR 85 QR , 10.00 BD/OMR	Approx.dia. 20 × H 9 cm				

### Acacia Deeper Plate

1-4549337083332	Approx.dia. 24 × H 5 cm	7.00KD ,85.00 AED/SAR, 80 QR , 9.00 BD/OMR
2-4549337083349	Approx.dia. 20 × H 4 cm	5.5.00KD ,65.00 AED/SAR, 60 QR , 7.00 BD/OMR
3-4549337083561	Approx.dia. 16 × H 3.5 cm	5.00KD ,55.00 AED/SAR, 50 QR , 6.00 BD/OMR

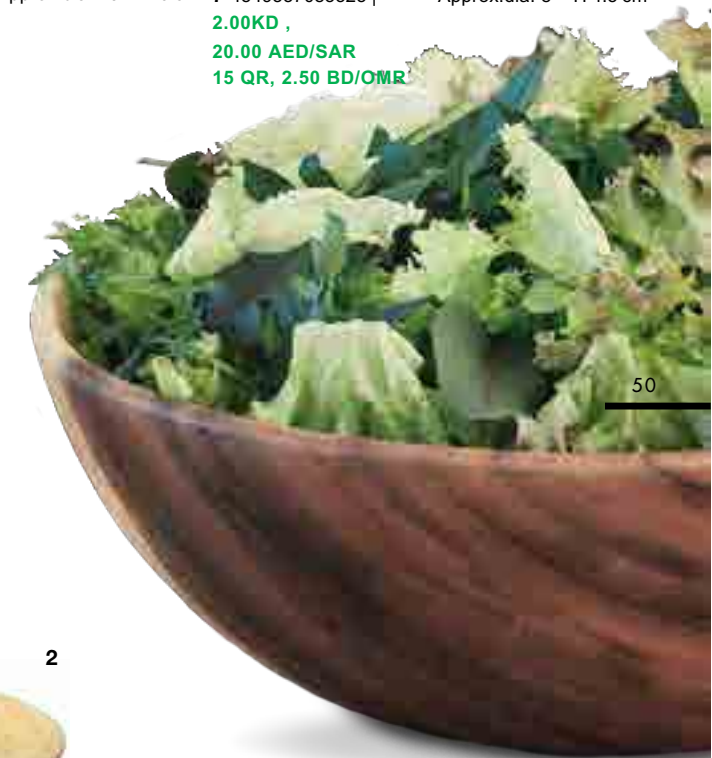

## Porcelain

MUJI porcelain is produced in Hasami, a region with long tradition of white porcelain craftsmanship, it's made with highly translucent Amakusa pottery stone.

### Beige Porcelain:



#### Porcelain Beige Deep Dish

<b>L-</b> 4547315254514   Approx.dia. 23.5 × H 5 cm <b>2.00KD ,30.00 AED/SAR/QR, 2.50 BD/OMR</b>	<b>M-</b> 4547315254507   Approx.dia. 19 × H 4.5 cm <b>1.75KD ,25.00 AED/SAR/QR, 2.25 BD/OMR</b>	<b>S-</b> 4547315254491   Approx.dia. 15 × H 3.5 cm <b>1.25KD ,20.00 AED/SAR/QR, 1.50 BD/OMR</b>
---	---	---



#### Beige Bowl

<b>L-</b> 4934761488400   Approx.dia. 16.5 cm <b>3.00KD ,40.00 AED/SAR /QR, 3.75 BD/OMR</b>
<b>M-</b> 4934761488417   Approx.dia. 12.5 cm <b>2.00KD ,30.00 AED/SAR /QR, 2.50 BD/OMR</b>
<b>S-</b> 4934761488424   Approx.dia. 11.5 cm <b>1.75KD ,25.00 AED/SAR /QR, 2.25 BD/OMR</b>



#### Porcelain Beige Stacking Bowl

<b>L-</b> 4547315254552   Approx.dia. 12 × H 5.5 cm <b>2.00KD ,25.00 AED/SAR/QR, 2.50 BD/OMR</b>	<b>M-</b> 4547315254545   Approx.dia. 10.5 × H 4.5 cm <b>1.75 KD , 20.00 AED/SAR/QR, 2.25 BD/OMR</b>	<b>S-</b> 4547315254538   Approx.dia. 9 × H 4 cm <b>1.50KD ,15.00 AED/SAR/QR, 2.00 BD/OMR</b>
---	---	--

#### Beige Plate

<b>1-</b> 4945247614220   Approx.dia. 26 cm <b>3.00KD ,40.00 AED/SAR/QR, 3.75 BD/OMR</b>
<b>2-</b> 4934761488370   Approx.dia. 23 cm <b>2.00KD ,30.00 AED/SAR/QR, 2.50 BD/OMR</b>
<b>3-</b> 4934761488387   Approx.dia. 19 cm <b>1.50KD ,20.00 AED/SAR/QR, 2.00 BD/OMR</b>
<b>4-</b> 4934761488394   Anprox.dia. 15 cm <b>1.00KD .15.00 AED/SAR/QR, 1.25 BD/OMR</b>

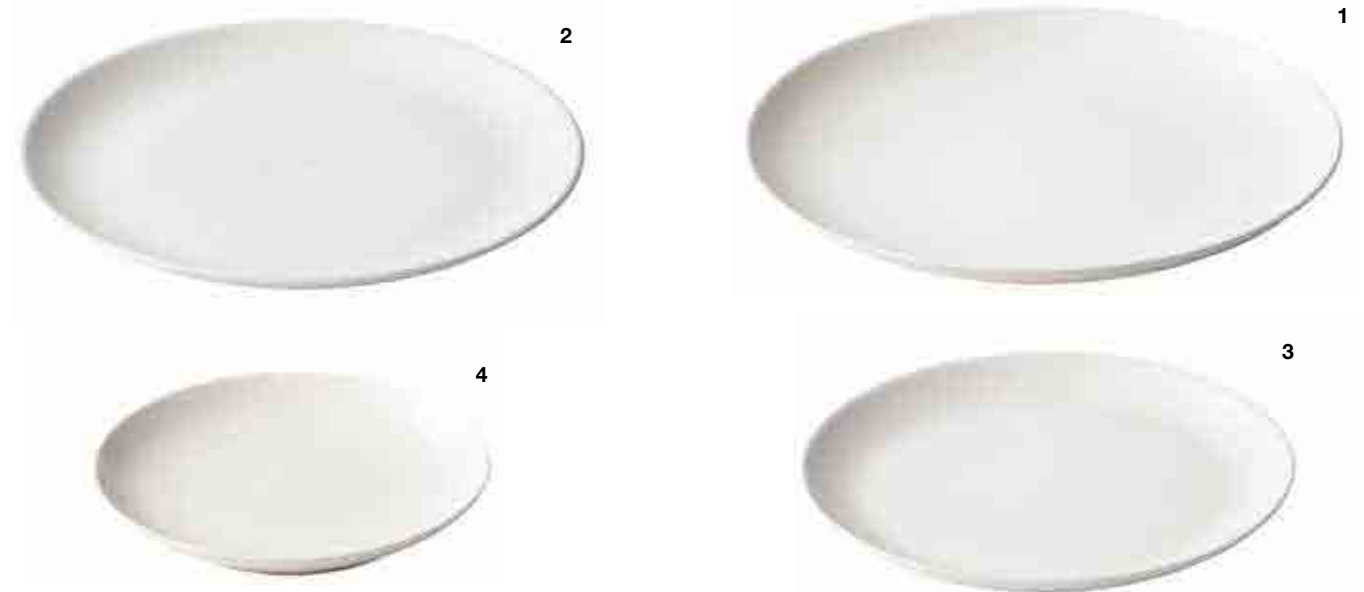

#### Stone Beige Bowl For Curry

<b>1-</b> 4549337390386   Approx.dia. 24 × H 5 cm <b>3.5KD ,40.00 AED/SAR/QR, 4.00 BD/OMR</b>
--







Porcelain Beige Square Plate / With Partition

1-4550002797164 | 25 × 18 × 2 cm  
5.00KD, 60.00 AED/SAR/QR  
6.50 BD/OMR



2-4550002797195 | 21 × 15 × 2 cm  
4.00KD, 50.00 AED/SAR/QR  
5.00 BD/OMR



Porcelain Beige Stacking Dip Bowl

4547315254521 | About dia. 7.5 × h 3.5 cm  
0.75KD, 10.00 AED/SAR/QR  
1.00 BD/OMR



Porcelain Beige Egg Cup

4549738306290 | Approx. dia. 5 × h 3.5 cm  
1.75KD, 20.00 AED/SAR/QR  
2.00 BD/OMR



Porcelain Beige Oval Plate

L-4934761383651 | 22 × 16 × 4.5 cm  
3.00KD, 35.00 AED/SAR/QR  
3.75 BD/OMR



M-4934761383569 | 14.5 × 10.5 × 3.5 cm  
1.75KD, 20.00 AED/SAR/QR  
2.00 BD/OMR



Porcelain Beige Cup

1-4547315916252 | 330ml 2.00KD,  
25.00 AED/SAR/QR, 2.50 BD/OMR  
2-4547315916245 | 210ml 1.75KD,  
20.00 AED/SAR/QR, 2.25 BD/OMR



Porcelain Beige Dish For Curry Rice

4934761383552 | 26 × 19.5 × 5 cm 5.00KD,  
60.00 AED/SAR/QR, 6.50 BD/OMR



Porcelain Beige Tea Pot

4550002797171 | Approx. 450 ml 8.00KD,  
100.00 AED/SAR/QR, 10.00 BD/OMR



Porcelain Beige Dripolator

4550002797188 | 11.5 × 9.5 cm 5.00KD,  
60.00 AED/SAR/QR, 6.50 BD/OMR



## White Porcelain:

### White Porcelain Dish

XI-4547315873661 | Approx.dia. 26 cm **9.00KD,**

**90.00 AED/SAR/QR, 12.00BD/OMR**

L- 4547315873678 | Approx.dia. 22 cm

**5.00KD/BD/OMR, 50.00 AED/SAR/QR**

M-4548718358212 | About dia. 19cm **3.50KD**

**40.00 AED/SAR/QR, 4.50 BD/OMR**

S-4548718358229 | About dia. 14.5 cm **2.00KD**

**30.00 AED/SAR/QR, 2.50BD/OMR**



L



XL



M



S

### White Porcelain Square Bowl

L-4547315873791 | 14.5 × 14.5 × 6 cm

**3.50KD, 40.00 AED/SAR/QR, 4.50 BD/OMR**

M- 4547315873814 | 11.5 × 11.5 × 5 cm

**2.50KD, 35.00 AED/SAR/QR, 3.25 BD/OMR**

S-4547315873807 | 8 × 8 × 4cm **1.75KD, 30.00**

**AED/SAR/QR, 2.25 BD/OMR**



M



L



S

### White Porcelain Donburi Bowl

L-4547315913053 | Dia. 16 × 8.5 cm

**4.00KD, 50.00 AED/SAR/QR, 5.00**

**BD/OMR**

S- 4547315581191 | About dia 13.5 × 7cm

**1.75KD ,30.00 AED/SAR/QR,**

**2.25BD/OMR**



L



S

### White Porcelain Rice Bowl

XL- 4548076421535 | Approx.dia. 13.5 × H 5.5 cm **2.50KD,**

**40.00 AED/SAR/QR, 3.25BD/OMR**

L- 4547315873746 | Approx.dia. 12.3 × H 5.5 cm **2.25KD,**

**35.00 AED/SAR/QR, 3.00 BD/OMR**

M- 4547315873753 | Approx.dia. 11.6 × H 5 cm **2.00KD, XL**

**30.00 AED/SAR/QR, 2.50 BD/OMR**



XL



L



M



### White Porcelain Shallow Bowl

L-4547315873821 | Dia. 15.5 × 5 cm

**2.50KD, 30.00 AED/SAR/QR, 3.25 BD/OMR**

S- 4548718358243 | About dia. 11.5 × 4 cm

**1.75KD, 20.00 AED/SAR/QR, 2.25 BD/OMR**



S



L

### White Porcelains Noodle Bowl

1- 4945247547917 | About dia. 21 cm **6.00KD**

**80.00 AED/SAR/QR, 7.50 BD/OMR**



1

### White Porcelain Tea Pot

L-4550182308761 | 550 ml **8.00KD,**

**100.00 AED/SAR/QR, 10.00 BD/OMR**

S- 4550182308754 | 360 ml **7.00KD,**

**90.00 AED/SAR/QR, 9.00 BD/OMR**



S



L



**White Porcelain Long Square Dish**

L- 4547315873715 | 22.4 × 6.7 cm **2.50KD**  
**,30.00 AED/SAR/QR, 3.50 BD/OMR**  
S-4547315873722 | 11 × 6.5 cm **1.75KD** ,  
**20.00 AED/SAR/QR, 2.50 BD/OMR**



**White Porcelain Square Dish**

**XL-** 4547315873739 | 22.4 × 12.2cm **3.50KD**  
**50.00 AED/SAR/QR, 4.50 BD/OMR,**  
**L-**4548076421511 | 18 × 18 cm **6.00KD**  
**80.00 AED/SAR/QR, 7.50 BD/OMR**  
**M-**4548076421528 | 12 × 12 cm **2.50KD**  
**35.00 AED/SAR/QR, 3.25 BD/OMR**



**White Porcelain Brevoort Plate**

1-4934761052182 | W 31 × D11 × 2.5cm  
**6.00KD, 80 AED/SAR/QR, 7.50 BD/OMR**



**White Porcelain Small Bowl**

4547315550203 | About dia. 8.5 × 6.5 cm  
**1.50KD, 20.00 AED/SAR/QR, 2.00BD/OMR**



**White Porcelain Mug Cup**

4547315873913 | 325 ml **2.50KD**  
**35.00 AED/SAR/QR, 3.25BD/OMR**



**White Porcelain Small Dish**

4548718358236 | About dia. 10 cm **1.50KD**  
**,20.00 AED/SAR/QR, 2.00 BD/OMR**



**White Porcelain Soy Sauce Pot Small**

4547315873944 | Dia. 6.2 × 8 cm **3.50KD,**  
**50.00 AED/SAR/QR, 4.50 BD/OMR**



**White Porcelain Ramen Multi Bowl**

4547315581207 | About dia. 20 × 6.5 cm  
**3.50KD, 50.00 AED/SAR/QR, 4.50 BD/OMR**



**White Porcelain Chinese Spoon**

4549738306306 | 14cm  
**1.75KD, 20.00 AED/SAR,**  
**19.00QR, 2.25 BD/OMR**



**White Porcelain Tea Cup**

4547315581214 | 230 ml **2.00KD,**  
**25.00 AED/SAR/QR, 3.00 BD/OMR**



**White Porcelain Round Tea Cup**

4547315873890 | 180 ml **1.75KD,**  
**25.00 AED/SAR/QR, 2.25 BD/OMR**

## Housekeeping



### Why MUJI Cleaning Systems?

Reliable, robust and multipurpose household utilities are the foundation of a clean and organised household. The utility range offers practical and dependable products for washing, cleaning and recycling:

- Maximum cleaning, minimum storage
- Light-weight telescopic pole
- Seven different attachments
- Choose from lint roller, duster, broom, brush or mop
- Replaceable, highly durable, parts

With the seven attachments you can clean any area of your house; high places, low places, floors, windows and bathrooms.



Quick & Clean Everyday!



1- Cleaning System Aluminium Telescope Pole

4550182221084 | Approx.dia 2.5 × L 68-116 cm.

2.50 KD, 30.00 AED/SAR/QR, 3.25 BD/OMR

3- Cleaning System Wooden Pole

4550182221114 | Approx.dia 2 × h 110 cm.

7.00 KD, 80.00 AED/SAR/QR, 8.50BD/OMR

5-Cleaning System Bath Brush

4550002526153 | Approx.W 7 × D 15 × H 20 cm.

1.75 KD, 20.00 AED/SAR/QR, 2.00 BD/OMR

7- Carpet Cleaner For Cleaning System

4547315259625 | W 18.3 × D 7.5 × H 27.5 cm.

3.00 KD, 35.00 AED/SAR, 30.00 QR, 3.50 BD/OMR

9- Flooring Mop

4549738936954 | Approx.W 25 × D 10 × H 16.5 cm.

3.00 KD, 35.00 AED/SAR, 30.00 QR, 3.50 BD/OMR

11- Handy Mop For Cleaning System

4547315259748 | About 42 cm.

5.00 KD, 60.00 AED/SAR, 55.00 QR, 6.00 BD/OMR

2- Cleaning System Lightweight Short Pole

4550182221091 | Approx.dia 2 × h 56 cm.

1.25 KD, 30.00 AED/SAR/QR, 1.5 BD/OMR

4- Cleaning System Wooden Short Pole

4550182221107 | Approx.dia 2 × h 55 cm.

5.50 KD, 65.00 AED/SAR/QR, 7.00 BD/OMR

6- Cleaning System Deck Brush

4550002526160 | Approx.W 18 × D 7 × H 17 cm.

2.00 KD, 25.00 AED/SAR/QR, 2.50 BD/OMR

8- Cleaning System Broom

4550182107173 | Approx.W 22 × D 3 × H 23 cm.

2.50 KD, 30.00 AED/SAR/QR, 3.25 BD/OMR

10- Cleaning Supplies System Squeegee

4549337494695 | About W 24 × D 7 × H 18 cm.

2.50 KD, 30.00 AED/SAR, 25.00 QR, 3.25 BD/OMR

12-Cleaning System Sponge For Bath

4550002526146 | Approx.W 9.5 × D 15 × H 17 cm.

1.75 KD, 20.00 AED/SAR/QR, 2.00 BD/OMR



13- Spot Cleaning Series Brush

4550002526177 | Approx.W 1.5 × L 20 cm.

0.60 KD, 7.00 AED/SAR/QR, 0.80 BD/OMR

15- Spot Cleaning Series Sponge

4550002526184 | Approx.W 2 × L 20 cm.

0.60 KD, 7.00 AED/SAR/QR, 0.80 BD/OMR

17- Brush For Tile Joint

4547315259816 | About W 3 × D 19 × H 9.5 cm.

1.25 KD, 15.00 AED/SAR, 12.00 QR, 1.50 BD/OMR

19- Wooden Gap Brush

4549337287693 | Approx.W 1 × D 17 × H 2 cm.

1.75 KD, 20.00 AED/SAR, 15.00 QR, 2.50 BD/OMR

21- Wooden Table Brush

4550182107166 | Approx.W 23 × D 1 × H 7 cm.

4.50 KD, 50.00 AED/SAR/QR, 6.00 BD/OMR

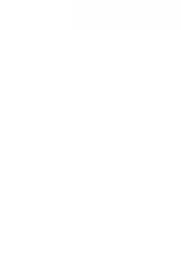

14- Spot Cleaning Series Spatula

4550002526214 | Approx.W 1 × L 20 cm

0.60 KD, 7.00 AED/SAR/QR, 0.80 BD/OMR

16- Spot Cleaning Series SpotBrush

4550002526184 | Approx.W 1 × L 20 cm

0.60 KD, 7.00 AED/SAR/QR, 0.80 BD/OMR

18- Urethane Foam 3 Layer Bath Sponge

4549738304623 | About W 7 × D 14.5 × H 4.5 cm

2.00 KD, 20.00 AED/SAR, 15.00 QR, 2.50 BD/OMR

20- Desk Broom Set With Dustpan

4547315259809 | Approx.W 16 × D 4 × H 17 cm

3.00 KD, 35.00 AED/SAR, 30.00 QR, 3.50 BD/OMR

22- Dustpan For Cleaning System

4547315259700 | About W 25 × D 34 × H 10.5 cm

1.25 KD, 15.00 AED/SAR, 12.00 QR, 1.50 BD/OMR



1- Portable Lint Roller  
4550002526283 | Approx. dia 3 × H 10 cm.  
**1.75 KD, 20.00 AED/SAR/QR, 2.00 BD/OMR**

2- Microfiber Mini Handy Mop (Sliding Handle)  
4547315259786 | About L 30-72cm.  
**4.00 KD, 50.00 AED/SAR, 45.00 QR, 5.00 BD/OMR**

3- Lint Roller  
4547315268368 | About W 6 × D 6 × H 21 cm.  
**2.50 KD, 30.00 AED/SAR, 25.00 QR, 3.00 BD/OMR**

4- Mini Handy Duster Micro  
4547315259779 | About L 33 cm.  
**3.00 KD, 35.00 AED/SAR, 30.00 QR, 3.50 BD/OMR**

5-Cleaning System Flooring Mop Case  
4549738755678 | Approx. W 27 × D 9 × H 15 cm.  
**2.50 KD, 30.00 AED/SAR/QR, 3.00 BD/OMR**

6-Microfiber Mop (Dry)  
4547315259649 | Approx. W 29 × D 14.5 × H 2.5 cm.  
**2.50 KD, 30.00 AED/SAR, 25.00 QR, 3.00 BD/OMR**

7-Microfiber Mop (Wet)  
4547315259656 | Approx. W 29 × D 14.5 × H 1.5 cm.  
**2.50 KD, 30.00 AED/SAR, 25.00 QR, 3.00 BD/OMR**



## Housekeeping / Spare & Refill



1- Adhesive Roller Refill  
4549738307266 | 16 cm.  
**2.00 KD, 25.00 SAR/AED**

2- Lint Roller Travel Refill  
4547315268375 | 8 cm  
**1.250 KD, 15.00 SAR/AED**

3- Portable Lint Roller Refill  
4550002526290 | 2 rolls  
**1.25 KD, 15.00 SAR/AED**

4-Cleaning System Sponge For Bath Refill  
4550002710422 | Approx. W 9 × D 15 × H 17 cm  
**1.250 KD, 15.00 SAR/AED**

5- Spare Sponge Squeegee  
4549738364566 | About 24 × 4 cm.  
**1.00 KD, 12.00 SAR/AED**

6- Refill Spatula for Glass Wiper  
4549738320838 | Approx. 24 × 2 cm  
**0.900 KD, 10.00 SAR/AED**

7- Refill Sheets for Flooring Mop Dry  
4550002526269 | 20 sheets  
**.75 KD, 12.00 SAR/AED**

8- Spare Brush For Handy Mop  
4547315259793 | About. 18 cm  
**2.00 KD, 20.00 SAR/AED**  
4547315259755 | About. 30 x 17 cm  
**3.50 KD, 45.00 SAR/AED**



Electronics



MUJI appliances bring comfort and convenience to your daily life by providing excellent functionality, user-friendliness, and style that fits well with other furniture and home decor.

## Clock

Simple clocks with high visibility and versatility.  
Designed focusing on the original purpose of a clock  
which is "an item to check the time."



Black

### Wall Clock / L

4547315915163 | Wall clock / White  
4547315915170 | Wall clock / Black

dia. 264 × D 4.5 mm

20.00 KD, 210.00 AED/SAR,  
199.00 QR, 25.00 BD/OMR



White

### Wall Clock / S

4547315915217 | Wall or table clock with  
stand / White

4547315915224 | Wall or table clock with  
stand / Black

14.00 KD, 150.00 AED/SAR  
139.00 QR, 16.00 BD/OMR

dia. 124 × D 44 mm

This wall mounted clock features the number  
font based on the ones used on clocks  
displayed in public facilities with emboss  
printed numbers for high-visibility.



### Railway Station Alarm Clock White

4549738673576 | Wall or table clock with  
alarm function / Ivory

16.00 KD, 200.00 AED/SAR  
195.00 QR, 20 BD/OMR

W 125 × D 40 × H 90 mm



### Cuckoo Clock Large

4547315832606 | Wall or table clock / White  
25.00 KD, 300.00 AED/SAR/QR,  
33.00 BD/OMR

W 255 × D 125 × H 267 mm

Each cuckoo clock features a carefully and  
individually crafted bellows. The large number  
face is easy to read when the clock is mounted  
on the wall. The clock is equipped with a light  
sensor for a night-silence feature.



### Cuckoo Clock

4547315832491 | Wall or table clock / White  
19.00 KD, 225.00 AED/SAR/QR,  
25.00 BD/OMR

W 95 × D 108 × H 204 mm



### Park Clock Mini

4547315832453 | Table clock / White  
4547315909322 | Table clock / Black

8.50 KD, 100.00 AED/SAR/QR,  
12.00 BD/OMR

W 55 × D 55 × H 182 mm

This clock features the same style of number  
face as used on clocks installed in public  
parks in Japan.



White

### Digital Clock L

4547315831975 | Wall or table clock with  
stand / White

4547315831982 | Wall or table clock with  
stand / Black

30.00 KD, 390.00 AED/SAR  
375.00 QR, 40 BD/OMR

W 240 × D 57 × H 115 mm



White

### Digital Clock With Alarm M

4547315831999 | Wall or table clock with alarm  
function and stand / White

4547315832002 | Wall or table clock with alarm  
function and stand / Black

W 180 × D 52 × H 88 mm  
20.00 KD, 260.00 AED/SAR  
250.00 QR, 25.00 BD/OMR



Black

### Digital Clock With Alarm S

4547315832019 | Wall or table clock with alarm  
function and stand / White  
W 115 × D 50 × H 39 mm

4547315832026 | Wall or table clock with alarm  
function and stand / Black

16.00 KD, 210.00 AED/SAR  
200.00 QR, 20.00 BD/OMR

W 115 × D 50 × H 39 mm

Featuring a well-balanced "hour / minute"  
display, focusing on the original purpose of a  
clock which is "an item to check the time."



### Analog Bath Clock

4550182114317 / White  
8.00 KD, 100.00 AED/SAR/QR,  
10.00 BD/OMR

A splash-proof clock that can be hung on a  
bathroom doorknob or hanger. It can also be  
used standing on its own.



### Beech Clock

4547315832682 | Table clock with alarm function  
13.00 KD, 150.00 AED/SAR/QR  
17.00 BD/OMR

W 70 × D 41.5 × H 70 mm

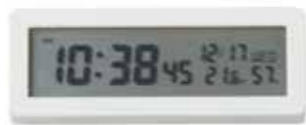

### Digital Clock With Loud Alarm

4547315832637 | Wall or table clock with  
alarm function / White

17.00 KD, 220.00 AED/SAR  
210.00 QR, 22.00 BD/OMR

Digital Alarm Clock with adjustable volume.  
With the function of a thermo-hygrometer, it  
helps monitor body condition.



### Digital Thermo-Hygrometer

4547315832392 | White  
4547315832408 | Black

8.00 KD, 100.00 AED/SAR  
95.00 QR, 10.00 BD/OMR

Adopts an LCD screen which can clearly be  
read from any angle, this digital thermo-  
hygrometer recalls the basic function of  
thermo-hygrometer: well-balanced display of  
temperature and humidity.



### Digital Bath Clock

4934761152516 | Splash-proof, table clock

8.00 KD, 100.00 AED/SAR/QR,  
10.00 BD/OMR

W 93 × D 26 × H 53 mm

This splash-proof clock includes a built-in  
thermometer, allowing you to monitor the  
temperature of the bathroom. Convenient  
timer and stopwatch functions make it easy to  
monitor your bath time.



### Aluminum Led Torch

4549738884811

23.00 KD, 275.00 AED/SAR/QR,  
30.00 BD/OMR

Dia. 4.3x15.2cm

With the waterproof feature, it can also be  
used freely at outdoors. It can switch between  
wider range light or spot focus light.



### Led Torch AA AAA Battery Applicable

L-4549738940807 / AA AAA Battery Applicable  
15.00 KD, 195.00 AED/SAR/QR, 20.00 BD/OMR

S-4549738940814 / AA Battery Applicable  
10.00 KD, 125.00 AED/SAR/QR, 12.50 BD/OMR

The torch is designed with a translucent shade,  
enabling it to be used as a desk light. It is easy to  
use as it works with a single AA battery and is  
waterproof to be used outdoors.



# Travel



Luggage

73



Travel Accessories

74



Bags & Totes

78

## Travel



When functional items are made portable, travel becomes comfortable and enjoyable. MUJI to go, offers an impressive range of travel essentials and lifestyle products especially curated to help add comfort and style for people on the go and travellers alike. MUJI's travel product range is compact, versatile and accessible to people on the move, for both work and leisure.



## Luggage

For a journey that's even smoother.

Muji suitcases (aka trolley) are some of the most under rated and best value spinner luggage you can find today.



### 1- Beige

**105 L**-4550182718492.  
120.00 KD, 1550.00 SAR/AED  
1500.00 QR, 155.00 BD/OMR

**20 L**-4550182718331.  
45.00 KD, 550.00 SAR/AED  
550.00 QR, 55.00 BD/OMR

**36 L**-4550182718379  
70.00 KD, 850.00 SAR/AED  
800.00 QR, 90.00 BD/OMR

**88 L**-4550182718454  
105.00 KD, 1350.00 SAR/AED  
1300.00 QR, 140.00 BD/OMR

### 1- Navy

**105 L**-4550182718508  
120.00 KD, 1550.00 SAR/AED  
1500.00 QR, 155.00 BD/OMR

**20 L**-4550182718348  
45.00 KD, 550.00 SAR/AED  
550.00 QR, 55.00 BD/OMR

**36 L**-4550182718386  
70.00 KD, 850.00 SAR/AED  
800.00 QR, 90.00 BD/OMR

**88 L**-4550182718461  
105.00 KD, 1350.00 SAR/AED  
1300.00 QR, 140.00 BD/OMR

### 1- Black

**105 L**-4550182718515  
120.00 KD, 1550.00 SAR/AED  
1500.00 QR, 155.00 BD/OMR

**20 L**-4550182718355  
45.00 KD, 550.00 SAR/AED  
550.00 QR, 55.00 BD/OMR

**36 L**-4550182718393  
70.00 KD, 850.00 SAR/AED  
800.00 QR, 90.00 BD/OMR

**63 L**-4550182718430  
85.00 KD, 1050.00 SAR/AED  
1000.00 QR, 110.00 BD/OMR  
**88 L**-4550182718478  
105.00 KD, 1350.00 SAR/AED  
1300.00 QR, 140.00 BD/OMR



MUJI Hard Carry Suitcases have a standard TSA lock function for safety.



Turning wheels for easy maneuvering. A major change on the wheel design, from single to double wheels, provides smoother and more stable movement.



The suitcase is made with a polycarbonate outer shell with an inner shell comprised of 70% polycarbonate and 30% ABS Resin and it is highly scratch-resistant. The light Poly-carbonate material keeps your luggage light, so you can pack more.



## Travel Accessories

### Gusset Case Collection

This cloth gusset case can be used to store and organise bulky clothes when travelling. It can be folded into a pocket size so as to save space.



#### Double S



#### Double M



## Passport Cases



### Black

4549738743668 | 23.5 x 13 x 2.5 cm  
11.00 KD, 130.00 SAR/AED, 120.00 QR, 14.00 BD/OMR

### Navy

4550002869144 | 23.5 x 13 x 2.5 cm  
11.00 KD, 130.00 SAR/AED, 130.00 QR, 14.00 BD/OMR

### Gray

4550002869137 | 23.5 x 13 x 2.5 cm  
11.00 KD, 130.00 SAR/AED, 130.00 QR, 14.00 BD/OMR

### Passport Clear Pocket Refill

4550002869137 | 23.5 x 13 x 2.5 cm  
11.00 KD, 130.00 SAR/AED, 130.00 QR, 14.00 BD/OMR

### 1- Black

**S**-4550002868918 | 20 x 26 x 10 cm.  
3.50 KD, 50.00 SAR/AED, 50.00 QR, 4.25 BD/OMR

**M**-4550002868925 | 20 x 40 x 10 cm  
4.50 KD, 60.00 SAR/AED, 60.00 QR, 5.50 BD/OMR

**L**-4550002868956 | 40 x 53 x 10 cm  
6.50 KD, 80.00 SAR/AED, 80.00 QR, 7.75 BD/OMR

**Double S**-4550002868932 | 20 x 26 x 10 cm  
4.50 KD, 60.00 SAR/AED, 60.00 QR, 5.50 BD/OMR

**Double M**-4550002868949 | 26 x 40 x 10 cm  
5.00 KD, 70.00 SAR/AED, 70.00 QR, 6.50 BD/OMR

### 2- Blue

**S**-4550002868963 | 20 x 26 x 10 cm  
3.50 KD, 50.00 SAR/AED, 50.00 QR, 4.25 BD/OMR

**M**-4550002868970 | 20 x 40 x 10 cm  
4.50 KD, 60.00 SAR/AED, 60.00 QR, 5.50 BD/OMR

**Double S**-4550002868987 | 20 x 26 x 10 cm  
4.50 KD, 60.00 SAR/AED, 60.00 QR, 5.50 BD/OMR

**Double M**-4550002868994 | 26 x 40 x 10 cm  
5.00 KD, 70.00 SAR/AED, 70.00 QR, 6.50 BD/OMR

### 3- Light Gray

**S**-4550002869007 | 20 x 26 x 10 cm  
3.50 KD, 50.00 SAR/AED, 50.00 QR, 4.25 BD/OMR

**M**-4550002869014 | 20 x 40 x 10 cm  
4.50 KD, 60.00 SAR/AED, 60.00 QR, 5.50 BD/OMR

**Double S**-4550002869021 | 20 x 26 x 10 cm  
4.50 KD, 60.00 SAR/AED, 60.00 QR, 5.50 BD/OMR

**Double M**-4550002869038 | 26 x 40 x 10 cm  
5.00 KD, 70.00 SAR/AED, 70.00 QR, 6.50 BD/OMR



### Black

4550002869106 | 23 x 12 cm  
6.00 KD, 70.00 SAR/AED, 70.00 QR, 7.50 BD/OMR

### Navy

4550002869120 | 23 x 12 cm  
6.00 KD, 70.00 SAR/AED, 70.00 QR, 7.50 BD/OMR

### Gray



4550002869113 | 23 x 12 cm  
6.00 KD, 70.00 SAR/AED, 70.00 QR, 7.50 BD/OMR

## Hanging Cases



Hanging case comes with a hook that can be hung against the bathroom door, towel rack, or wall. It is ideal for organising toiletries for your travel.





Hanging Box Case

-  **Black**  
4550002125752 | 16 x 19 x 6 cm  
10.00 KD, 115.00 SAR/AED  
115.00 QR, 12.00 BD/OMR
-  **Navy**  
4550002868789 | 16 x 19 x 6 cm  
10.00 KD, 115.00 SAR/AED  
115.00 QR, 12.00 BD/OMR
-  **Gray**  
4550002868772 | 16 x 19 x 6 cm  
10.00 KD, 115.00 SAR/AED  
115.00 QR, 12.00 BD/OMR

Hanging Box Case / Small Item Pockets

-  **Black**  
4550002125721 | 12 x 18 cm  
6.00 KD, 70.00 SAR/AED  
70.00 QR, 7.50 BD/OMR
-  **Navy**  
4550002868765 | 12 x 18 cm  
6.00 KD, 70.00 SAR/AED  
70.00 QR, 7.50 BD/OMR
-  **Gray**  
4550002868758 | 12 x 18 cm  
6.00 KD, 70.00 SAR/AED  
70.00 QR, 7.50 BD/OMR

Hanging Case With Detachable Pouch

-  **Black**  
4550002125691 | 12 x 18 x 4.5 cm  
6.00 KD, 70.00 SAR/AED  
70.00 QR, 7.50 BD/OMR
-  **Navy**  
4550002868741 | 12 x 18 x 4.5 cm  
6.00 KD, 70.00 SAR/AED  
70.00 QR, 7.50 BD/OMR
-  **Gray**  
4550002868734 | 12 x 18 x 4.5 cm  
6.00 KD, 70.00 SAR/AED  
70.00 QR, 7.50 BD/OMR



EVA Hanging Case

- 4550182203011 | 22 x 13.5 x 5 cm  
6.50 KD, 80.00 SAR/AED  
80.00 QR, 8.50 BD/OMR

## Neck Cushions



In Fitting Neck Cushion, there are "approx. 5 million" of microparticle beads stuffed inside.

Those large amount of microparticle beads have high fluidity, therefore, it moves and fits in accordance with the movement of user's neck.





Fitting Neck Cushion With Hood

A hooded neck cushion that covers the face when sleeping in a public space, such as air plane. Hood can be stored when not in use.

-  **Melange Black**  
4550002868512 | 16.5 x 67 cm  
15.00 KD, 170.00 SAR/AED  
170.00 QR, 19.00 BD/OMR
-  **Melange Navy**  
4550002868529 | 16.5 x 67 cm  
15.00 KD, 170.00 SAR/AED  
170.00 QR, 19.00 BD/OMR

Curved Fitting Neck Cushion



It is made of elastic soft fabric filled with super tiny beads. It can be used in different ways to provide comfort and relaxation to your neck and waist.

-  **Black**  
4550002868581 | 15.5 x 61 cm  
11.00 KD, 130.00 SAR/AED  
130.00 QR, 14.00 BD/OMR
-  **Navy**  
4550002868574 | 15.5 x 61 cm  
11.00 KD, 130.00 SAR/AED  
130.00 QR, 14.00 BD/OMR

Polyester Portable Neck Cushion

-  **Black**  
4550182202809 | 39 x 46 cm  
7.00 KD, 80.00 SAR/AED  
80.00 QR, 9.00 BD/OMR

Fitting Neck Cushion

-  **Melange Black**  
4550002868536 | 16.5 x 67 cm  
11.00 KD, 130.00 SAR/AED  
130.00 QR, 14.00 BD/OMR
-  **Melange Navy**  
4550002868543 | 16.5 x 67 cm  
11.00 KD, 130.00 SAR/AED  
130.00 QR, 14.00 BD/OMR





**Polyester Portable Room Shoes**

Portable room shoes that can be folded compactly. Come with storage bag for easy portability.



Size: 22 X 24.5 cm

4550182202786  
3.50 KD, 45.00 SAR/AED  
45.00 QR, 4.25 BD/OMR

Size: 24.5 x 27 cm

4550182202793  
3.50 KD, 45.00 SAR/AED  
45.00 QR, 4.25 BD/OMR

**Polyester Portable Sleeping Mask**



Black

4550182202816 | 8.5 x 20.0 cm  
3.50 KD, 45.00 SAR/AED  
45.00 QR, 4.25 BD/OMR

**Bags & Totes**

**Paraglider Cloth Foldable Rucksack**

Made of paraglider cloth, the foldable bag is easy to store and carry.



Black

4550002994464 | Foldable  
17.00 KD, 210.00 SAR/AED  
200.00 QR, 21.00 BD/OMR

Navy

4550002994457 | Foldable  
17.00 KD, 210.00 SAR/AED  
200.00 QR, 21.00 BD/OMR

**Tote & Shoulder Bag**

Paraglider cloth material. Can be hung over carry bag.

Black

4550182293104 | Foldable  
16.00 KD, 200.00 SAR/AED  
190.00 QR, 20.00 BD/OMR

Navy

4550182293098 | Foldable  
16.00 KD, 200.00 SAR/AED  
190.00 QR, 20.00 BD/OMR

**Rucksack**

Length of bag adjustable. Fits A4 files and can be stored when not used.



Black

4550182293784  
12.00 KD, 150.00 SAR/AED, 150.00 QR, 15.00 BD/OMR

Light Beige

4550182286489 | 15.5 x 61 cm  
12.00 KD, 150.00 SAR/AED, 150.00 QR, 15.00 BD/OMR

Navy

4550182286465  
12.00 KD, 150.00 SAR/AED, 150.00 QR, 15.00 BD/OMR

Gray

4550182293791  
12.00 KD, 150.00 SAR/AED, 150.00 QR, 15.00 BD/OMR

**Travel Boston Bag**

Paraglider cloth material. Can be hung over carry bag.

Black

4550182293074 | Foldable  
20.00 KD, 250.00 SAR/AED, 220.00 QR, 25.00 BD/OMR

Navy

4550182293067 | Foldable  
20.00 KD, 250.00 SAR/AED, 220.00 QR, 25.00 BD/OMR



Health & Beauty



Essential Oils 81



Aroma Diffuser 85



Skin Care 87

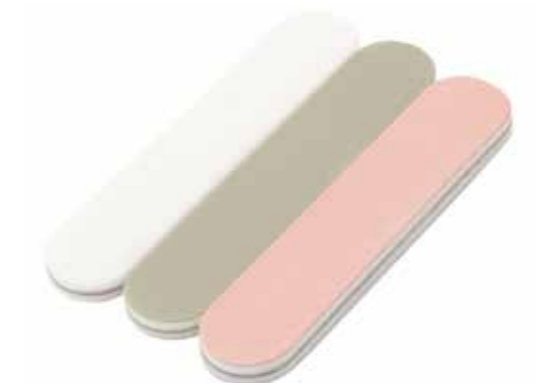

Nail care 90



Pet bottles 91



Cosmetic Tools 93



Cut Cotton & Cotton Buds 95



Nylon Makeup Boxes 97



## Essential oils

MUJI Essential Oils are pure and natural, from flowers and fruits harvested in areas they are famous for, such as Lavender from Provence, and Lemon or Blood Orange from Sicily Islands in Italy.

### What are essential oils?

Essential oils are the volatile molecules of a plant that most commonly provide it with fragrance, flavour and often therapeutic or aroma-therapeutic properties. They are extracted either through steam distillation of the leaves, wood and/or flowers, or cold expressed from the rind or peel.

The amount of oil extracted varies from plant to plant depending on the number of oil glands and method of extraction. For instance, it will take between 18 - 16 oranges to produce 10ml of essential oil; however, approximately 100kg of rose flowers will make 10ml of essential oil.



## Herb & Flower

Herb aroma is recommended for relaxing.

10 ml - **5.00 KD, 60.00 AED/SAR/QR, 6.00 BD/OMR**

30 ml - **11.00 KD, 130.00 AED/SAR/QR, 13.00 BD/OMR**



### Lavender

4550002546618	10 ml
4550002546625	30 ml

Its woody based gentle floral scent eases tension and has calming effect.



### Geranium

4550002546670	10 ml
4550002546687	30 ml

It gives out a sweet and deep aroma similar to a rose. It stabilises the mind and brightens the mood. It is known that insects show aversion to the smell.



### Lemongrass

4550002546656	10 ml
4550002546663	30 ml

Its sharp refreshing scent produces a cooling sensation. It is known that insects show aversion to the smell.



### Rosemary

4550002546632	10 ml
4550002546649	30 ml

Its clear and cool scent is refreshing and energizes the body. It has been used as an insect repellent or to remove the smell of meat since ancient times.

## Citrus

The citrus aroma is recommended for energising.

10 ml - **5.00 KD, 60.00 AED/SAR/QR, 6.00 BD/OMR**

30 ml - **11.00 KD, 130.00 AED/SAR/QR, 13.00 BD/OMR**



### Sweet Orange

4550002546731	10 ml
4550002546748	30 ml

This is characterised by the sweet and fresh scent representing the citrus group. It is said to brighten and calm the mind.



### Grapefruit

4550002546779	10 ml
4550002546786	30 ml

It gives out a familiar refreshing scent with subtle bitterness to it. It lifts the mood and boosts the spirits.



### Lemon

4550002546816	10 ml
4550002546823	30 ml

Its crisp, tart citrus scent refreshes and brightens the mood.



### Bergamot

4550002546793	10 ml
4550002546809	30 ml

Of all the citrus fragrance group, this gives out the sweetest, warmest citrus scent with floral note. It brightens and calms the mind.



### Lime

4550002546854	10 ml
4550002546861	30 ml

Lime has a tart and bitter citrus aroma. It has a delightfully refreshing scent that brightens the mood.

## Mint & Wood

The Mint and Wood aroma is recommended for the time for refreshing.

10 ml - **5.00 KD, 60.00 AED/SAR/QR, 6.00 BD/OMR**

30 ml - **11.00 KD, 130.00 AED/SAR/QR, 13.00 BD/OMR**



### Eucalyptus

4550002546519	10 ml
4550002546526	30 ml

Its minty sharp scent brightens the mood and helps you stay focused.



### Tea Tree

4550002546533	10 ml
4550002546540	30 ml

Its clear and clean scent, like medicine brightens a dull mood, producing a refreshing feeling. It comes in handy during the pollen seasons in spring and autumn.



### Peppermint

4550002546557	10 ml
4550002546564	30 ml

Its refreshing menthol scent helps you stay focused.



### Japanese Cypress

4550002546878	10 ml
4550002546885	30 ml

This woody scent is familiar to Japanese people. Its crisp and nostalgic scent makes the mind calm and relaxed period

## Blending Essential Oils

Step 1:

Select an essential oil according to the benefit you would like to produce. Smell the oil, and if you like it then put it to one side.

Step 2:

Look at the benefits related to the oils and select an oil that produces the benefit you are looking for.

Step 3:

Hold the two selected oils in one hand and waft the scent towards your nose, if you like the general scent continue to Step 5, alternatively return to step 2 and select a different essential oil.

## Blending based on aroma

Step 1:

Select an essential oil based on the aroma, i.e. smell the different oils and select the one you like.

Step 2:

Select an oil and hold it in one hand alongside your original and waft the scent towards your nose, if you like the general odour continue to step 3.

Step 4:

Once you have selected your oils, smell each individually and compare strengths. If one is a lot stronger than the other, use less drops. If they are both equally strong, use equal amounts. (Note: this is also subjective, you may prefer the fragrance of one oil over the other and decide that you would like to increase the strength of that oil by using more drops).

Step 5:

Apply the blend according to the usage chart.



	Bergamot	Eucalyptus	Grapefruit	Lavender	Lemon	Lemongrass	Orange	Yang Yang
Bergamot	•	•	•	•	•	•	•	•
Eucalyptus	•	•	•	•	•	•	•	•
Grapefruit	•	•	•	•	•	•	•	•
Lavender	•	•	•	•	•	•	•	•
Lemon	•	•	•	•	•	•	•	•
Lemongrass	•	•	•	•	•	•	•	•
Orange	•	•	•	•	•	•	•	•
Yang Yang	•	•	•	•	•	•	•	•

## Essential oil blending compatibility chart

Relaxing & Calming
Refreshing & Invigorating
Strengthening & Reviving

## Aroma Stone with Plate

Apply your desired fragrance, like fragrance oil and essential oil, on aroma stone to enjoy the fragrance.

**3.25 KD, 40.00 AED/SAR/QR, 4.25 BD/OMR**



Aroma Stone

4550002868291 / **Gray**



Aroma Stone

4550002868284 / **White**





## Aroma Diffuser

The Ultrasonic Aroma Diffuser is great to enjoy the original aroma of essential oil because it changes water and essential oil into the mist foam to spread around the rooms without adding the heat.



### Ultrasonic Aroma Diffuser

4547315880621 / **Small.**

The ultrasonic waves spread the aroma to enjoy together with the lights.

The white cylinder houses a lamp that shines with an ambient glow and has 2 light settings.

29.00 KD, 315.00 SAR/AED, 299.00 QR, 35.00 BD/OMR



### Ultrasonic Aroma Diffuser

4549738380283 / **Large**

Plenty of mist with pleasure of aroma even in a large room. 3-2 drops of essential oils for 100ml of water

39.00 KD, 415.00 SAR/AED, 399.00 QR, 45.00 BD/OMR

#### Operation:

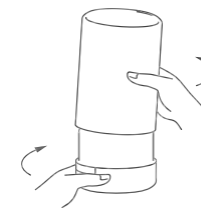

1. Twist anticlockwise to open the cover

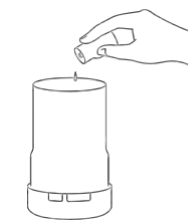

2. Pour the required amount of water into the tank, using the measuring cup provided. 3-2 drops of essential oils should be added for 100ml of water.

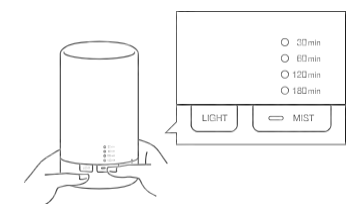

3. Plug in the adapter to the power supply and switch on.



### Portable Aroma Diffuser

4550002494063 17.00 KD, 200.00 SAR/AED/QR, 17.00 BD/OMR



The portable diffuser can be charged by USB. Its rechargeable battery can be charged via a laptop with a USB cable, and lasts up to eight hours.



Muji fitted it with a small fan so that it needs just a few drops of oils, rather than water.



The Portable Aroma Diffuser comes with a black cushioned case accompanied with pockets inside to hold a charging cable and a 10-millilitre essential oil bottle.

## Skincare

**MUJI's Sensitive Skincare Series is derived from natural waters of Kamaishi caves in the Iwate Prefecture.**

The silky natural water pumped out from the cave is extremely soft, with almost the same pH level as human tears, hence it's able to soak rapidly into the skin.

Irritation on the skin is caused by many factors such as environment, stress and tiredness, so MUJI considers the importance of skincare that is gentle on the skin.

MUJI's sensitive skincare range is hypoallergenic, fragrance-free, Paraben free and Alcohol free, with no added colours or mineral oils. All skincare ranges contain natural flower and fruit extracts. This makes the skincare range suitable for everyone.





## Cleansing



### Oil Cleansing

4548076448860	200 ml - <b>6.00 KD, 70.00 SAR/AED/QR, 8.00 BD/OMR</b>
4548076448877	50 ml - <b>2.50 KD, 30.00 SAR/AED/QR, 3.50 BD/OMR</b>

This cleanser contains plant-derived cleansing ingredients to protect sensitive skin. The oil ingredients, primarily olive oil, are 100% botanical.

## Toning:



### Light Toning Water • Light

4548076444947	200 ml - <b>4.25 KD, 50.00 SAR/AED/QR, 6.00 BD/OMR</b>
4548076446026	50 ml - <b>1.25 KD, 15.00 SAR/AED/QR, 1.75 BD/OMR</b>

Hypoallergenic toner protects delicate skin against dryness.



### Light Toning Water • Moisture

4548076444954	200 ml - <b>4.25 KD, 50.00 SAR/AED/QR, 6.00 BD/OMR</b>
4548076446071	50 ml - <b>1.25 KD, 15.00 SAR/AED/QR, 1.75 BD/OMR</b>



### Light Toning Water • High Moisture

4548076444961	200 ml - <b>4.25 KD, 50.00 SAR/AED/QR, 6.00 BD/OMR</b>
4548076446156	50 ml - <b>1.25 KD, 15.00 SAR/AED/QR, 1.75 BD/OMR</b>

## Moisturising



### Moisturising Milk • Light

4548076448358	200 ml - <b>4.25 KD, 50.00 SAR/AED/QR, 6.00 BD/OMR</b>
4548076448389	50 ml - <b>1.25 KD, 15.00 SAR/AED/QR, 1.75 BD/OMR</b>

Use after toner for an extra boost of moisture that leaves dry skin hydrated and super soft.



### Moisturising Milk • Moisture

4548076448365	200 ml - <b>4.25 KD, 50.00 SAR/AED/QR, 6.00 BD/OMR</b>
4548076448396	50 ml - <b>1.25 KD, 15.00 SAR/AED/QR, 1.75 BD/OMR</b>



### Moisturising Milk • High Moisture

4548076448372	200 ml - <b>4.25 KD, 50.00 SAR/AED/QR, 6.00 BD/OMR</b>
4548076448402	50 ml - <b>1.25 KD, 15.00 SAR/AED/QR, 1.75 BD/OMR</b>



### Moisturising Cream

4548076448693	50 g - <b>4.25 KD, 50.00 SAR/AED/QR, 6.00 BD/OMR</b>
---------------	--

use as your final skincare step to seal in the moisturising ingredients provided by toner and Moisturising Milk.

## Nail Care



### Nail Polish

4548076103240  
Made from soft urethane with shining and filing components that that give your nails a shine.  
**0.90 KD, 10.00 SAR/AED/QR, 1.25 BD/OMR**



### Nail File - Soft / 2pcs

4548718555116  
It smoothens the surface of the nails by removing uneven areas.  
**1.25 KD, 20.00 SAR/AED/QR, 1.25 BD/OMR**



### Nail File - Hard / 2pcs

4548718555109  
It shapes length and shape of the nails without harming them.  
**1.25 KD, 20.00 SAR/AED, 15.00 QR, 1.50 BD/OMR**



### Stainless Steel Folding Nail File

4547315852543 / 12.3 cm  
**1.50 KD, 20.00 SAR/AED, 15.00 QR, 2.00 BD/OMR**



### Steel Nail Clipper

**S** - 4547315822706 **2.50 KD, 35.00 SAR/AED, 30.00 QR, 3.00 BD/OMR**  
**L** - 4547315822690 **4.50 KD, 55.00 SAR/AED, 50.00 QR, 5.5 BD/OMR**

It is featured with precision blade which gives clear cut. You can cut the nails nicely and easily.

The file grooves are curved by laser, even the tip of file can be used. It is best used for precise and detailed care on nails. How to use: First, shape the nail's length with the coarse side. Then, polish the nail with the finer side. \*There is a marking "\*" on the base of the file for coarse side.



### Nail Care Set

4548718555123 **1.25 KD, 20 SAR/AED, 15.00 QR, 1.50 BD/OMR**

Set containing nail polish and nail file. Compact size makes it easy to carry. Pink: hard nail file, grey: soft nail file, white: nail buffer. File nails to desired length and shape using the rough surface (dark pink) and finish with the fine surface (light pink). Do not use on the surface of the nails.

# Pet Bottles

## Foam Type:

"The 'foam type' pump turns liquid soap into foam, which allows you to reduce the amount you use by up to 75%. Mix liquid soap and water. These bottles are not suitable for alcohol, petrol or solvent based products of any kind, including perfumes & vinegar.



Foam Type / Clear	Foam Type / White	Foam Type / Typolyethylene
250 ml- 4945247506754 – 1.75 KD, 25.00 SAR/AED/QR, 2.25 BD/OMR	250 ml- 4945247506778 – 1.75 KD, 25.00 SAR/AED/QR, 2.25 BD/OMR	50 ml- 4945247506846 – 1.25 KD, 20 SAR/AED/QR, 1.75 BD/OMR
400 ml- 4945247506761 – 2.00 KD, 30.00 SAR/AED/QR, 2.50 BD/OMR	400 ml- 4945247506785 – 2.00 KD, 30.00 SAR/AED/QR, 2.50 BD/OMR	

## Pump Type:

Square-shaped plastic bottles make use of all available space in narrow bathrooms and sink areas. Bottles that are convenient for refill of shampoo and conditioner. Tidy and organise your toiletries with these streamlined bottles made from PET. Not suitable for alcohol, petrol or solvent based products of any kind, including perfumes & vinegar.



Pump Type / Clear	Pump Type / White	Pump Type / Clear Gray
250 ml- 4547315853830 – 1.75 KD, 25.00 SAR/AED/QR, 2.25 BD/OMR	250 ml- 4548076712565 – 1.75 KD, 25.00 SAR/AED/QR, 2.50 BD/OMR	400 ml- 4550002868185 – 2.00 KD, 30.00 SAR/AED/QR, 2.50 BD/OMR
280 ml- 4547315853854 – 1.75 KD, 25.00 SAR/AED/QR, 2.25 BD/OMR	280 ml- 4548076712558 – 1.75 KD, 25.00 SAR/AED/QR, 2.50 BD/OMR	600 ml- 4550002868192 – 2.25 KD, 35.00 SAR/AED/QR, 3.00 BD/OMR
400 ml- 4550002867928 – 2.00 KD, 30.00 SAR/AED/QR, 2.50 BD/OMR	400 ml- 4550002867775 – 2.00 KD, 30.00 SAR/AED/QR, 2.50 BD/OMR	
600 ml- 4550002867935 – 2.25 KD, 35.00 SAR/AED/QR, 3.00 BD/OMR	600 ml- 4550002867782 – 2.25 KD, 35.00 SAR/AED/QR, 3.00 BD/OMR	

Pump Type / Gray
400 ml- 4550002868161 – 2.00 KD, 30.00 SAR/AED/QR, 2.50 BD/OMR
600 ml- 4550002868178 – 2.25 KD, 35.00 SAR/AED/QR, 3.00 BD/OMR



## Travel Bottles:

Due to security regulations at airports, MUJI developed a range of travel bottles that are all 100ml or smaller in size.

Available in screw top lids for lotions, spray tips for water based liquids, pump lids for moisturisers and creams, and flip caps ideal for liquid based substances such as shampoo.

These bottles are made from P.E.T. plastic and are not suitable for alcohol, petrol or solvent based products of any kind, including perfumes & vinegar.



Pet Bottle With Cap	Pet Pump Bottle	Pet Spray Bottle
30 ml- 4548718994212 - 0.50 KD, 5.00 SAR/AED/QR, 0.75 BD/OMR	15 ml- 4548718994236 – 0.90 KD, 10.00 SAR/AED/QR, 1.25 BD/OMR	12 ml- 4549337461475 – 1.00 KD/BD/OMR, 10.00 SAR/AED, 9.00 QR,
50 ml- 4548718994229 – 0.75 KD, 10.00 SAR/AED/QR, 1.00 BD/OMR	30 ml- 4548718994243 – 1.15 KD, 15.00 SAR/AED/QR, 1.50 BD/OMR	18 ml- 4549337461482 – 1.00 KD, 12.00 SAR/AED/QR, 1.35 BD/OMR
100 ml- 4548718994359 – 1.25 KD, 20.00 SAR/AED, 15.00 QR, 1.50 BD/OMR	50 ml- 4548718994250 – 1.25 KD, 20.00 SAR/AED/QR, 1.75	30 ml- 4548718994298 – 1.15 KD, 15.00 SAR/AED/QR, 1.50 BD/OMR
Bottle ideal for separating lotion, etc. Heat proof: 60 degrees Celsius , cold resistant: -20 degrees Celsius.	100 ml- 4548718994267 – 2.00 KD, 30.00 SAR/AED, 25.00 QR, 2.50 BD/OMR	50 ml- 4548718994304 – 1.25 KD, 20.00 SAR/AED/QR, 1.75 BD/OMR
	It is suitable for lotion division. Press several times until the content comes out. Heat resistance: 60 degrees Celsius Cold resistance: -20 degrees Celsius	100 ml- 4548718994311 – 2.00 KD, 30.00 SAR/AED, 25.00 QR, 2.50 BD/OMR
		Bottle ideal for separating lotion, etc. *Press several times until contents come out. Heat proof: 60 degrees Celsius , cold resistant: -20 degrees Celsius

Polyethylene Bottle With Cap	Polyethylene Tube
12 ml- 4548718994151 – 0.35 KD, 3.00 SAR/AED/QR, 0.50 BD/OMR	30 g- 4550182202878 – 0.50 KD, 7.00 SAR/AED/QR, 0.75 BD/OMR
18 ml- 4548718994168 – 0.45 KD, 4.00 SAR/AED/QR, 0.65 BD/OMR	50 g- 4550182202885 – 1.00 KD/BD/OMR, 12.00 SAR/AED/QR
30 ml- 4548718994175 – 0.50 KD, 5.00 SAR/AED/QR, 0.75 BD/OMR	A squeezable bottle that's easy to use. Great for shampoo, conditioners, and liquids.
50 ml- 4548718994182 – 0.75 KD, 10.00 SAR/AED/QR, 1.00 BD/OMR	Heat resistance: 80 degrees Celsius Cold resistance: -20 degrees Celsius.
100 ml- 4548718994366 – 1.25 KD, 20.00 SAR/AED, 15.00 QR, 1.50 BD/OMR	
The bottle made of soft resin which is easy to squeeze out content. Heat resistance: 90 degrees Celsius Cold resistance: -20 degrees Celsius.	



## Cosmetic Tools

### Makeup Brushes:

The brushes are made of plant-derived polyester fiber.

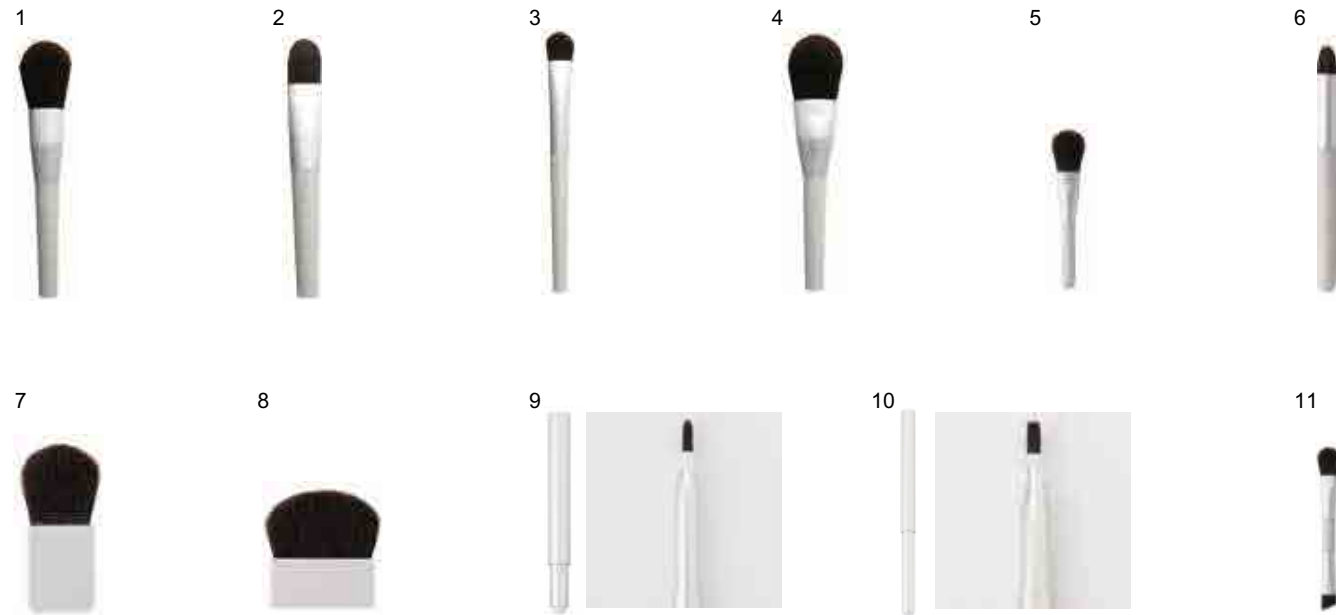

- |  |   |  |
|--|---|--|
| <p><b>1-Cheek Brush</b><br/> <b>93 ml-</b> 4549337385887 –<br/> <b>6.50 KD, 80.00 SAR/AED, 75.00 QR, 8.50 BD/OMR</b><br/> <b>153 ml-</b> 4547315822799 –<br/> <b>7.50 KD, 90.00 SAR/AED, 85.00 QR, 9.00 BD/OMR</b><br/> <b>164 ml-</b> 4547315822829 -<br/> <b>6.50 KD, 80.00 SAR/AED, 75.00 QR, 8.50 BD/OMR</b><br/>                     The brush is made of plant-derived polyester fiber which is not prone to curl and gives a soft touch to the skin. The small size is convenient for the portability.</p>  | <p><b>2-Foundation Brush</b><br/>                     4547315822904 / 136 mm -<br/> <b>6.50 KD, 80.00 SAR/AED , 75.00 QR, 8.50 BD/OMR</b><br/>                     The brush is made of plant-derived polyester fiber, which is supple and can apply liquid foundation evenly. How to use: take appropriate amount of liquid foundation on the back of the hand, use the brush to blend on the skin evenly.</p> | <p><b>3-Eye Colour Brush</b><br/>                     4547315822812 / 126 mm –<br/> <b>3.50 KD, 45.00 SAR/AED, 40.00 QR, 5.00 BD/OMR</b><br/>                     The brush is made of plant-derived polyester fiber which gives a soft touch to the skin.<br/>                     How to use: take appropriate amount of liquid foundation on the back of the hand, use the brush to blend on the skin evenly.</p> |
| <p><b>4-Face Brush</b><br/> <b>105 ml-</b> 4549337385870 –<br/> <b>8.00 KD, 100.00 SAR/AED/QR, 10.00 BD/OMR</b><br/> <b>146 ml-</b> 4547315822805 –<br/> <b>8.00 KD, 100.00 SAR/AED/QR, 10.00 BD/OMR</b><br/> <b>168 ml-</b> 4547315822836 -<br/> <b>7.00 KD, 100 SAR/AED/QR, 9.00 BD/OMR</b><br/>                     The brush is made of plant-derived polyester fiber which is not prone to curl and gives a soft touch to the skin. The trimmed flat with a volume is the ideal shape for face brush. How to use: Use the brush to take out appropriate amount of cheek colour, adjust the colour on the tissue paper first before applying on the face to create a natural makeup.</p> | <p><b>5-Eye Shadow Brush</b><br/>                     4550002868024 –<br/> <b>1.25 KD, 15.00 SAR/AED/QR, 1.50 BD/OMR</b><br/>                     Can be stored in the makeup palette.</p>  | <p><b>6-Lip Brush For Case</b><br/>                     4550002868048 –<br/> <b>1.00 KD, 10.00 SAR/AED/QR, 1.25 BD/OMR</b></p>   |
| <p><b>9-Aluminium Polyester Lip Brush</b><br/>                     4549337385863-<br/> <b>2.25 KD, 30.00 SAR/AED/QR, 3.00 BD/OMR</b><br/>                     The brush is made of plant-derived polyester fiber which is not prone to curl and gives soft touch to the skin. It is supple and can be used to blend on the lips evenly. It can be stored easily and conveniently.</p>  | <p><b>10-Aluminium Polyester Lip Brush</b><br/>                     4549337385856 –<br/> <b>3.00 KD, 35 SAR/AED, 30.00 QR, 3.50 BD/OMR</b><br/>                     The brush is made of plant-derived polyester fiber which is not prone to curl and gives soft touch to the skin. It is supple and can be used to blend on the lips evenly. It can be stored easily and conveniently.</p>                     | <p><b>8-Loose Powder Brush</b><br/>                     4550002868093 –<br/> <b>1.75 KD, 20.00 SAR/AED/QR, 2.00 BD/OMR</b><br/>                     Can be stored in the makeup palette.</p>   |
| <p><b>11- Eye Brow Brush</b><br/>                     4550002868031 –<br/> <b>1.25 KD, 15.00 SAR/AED/QR, 1.50 BD/OMR</b></p>   |   |  |

### Makeup Application:



- |   |   |  |
|---|---|--|
| <p><b>1-Eyebrow Brush Comb</b><br/>                     4547315822843 –<br/> <b>3.00 KD/BD/OMR, 35.00 SAR/AED, 30.00 QR</b></p>   | <p><b>2-Eye Colour Tip</b><br/>                     4547315822867 –<br/> <b>3.00 KD/BD/OMR, 35.00 SAR/AED, 30.00 QR</b></p>   | <p><b>3-Makeup Sponge</b><br/>                     4550002547578 / 40 pcs –<br/> <b>3.00 KD, 35.00 SAR/AED/QR, 4.00 BD/OMR</b><br/>                     The shape of this sponge makes it easy to finish makeup around the eyes and the wings of the nose.</p>   |
| <p><b>4-Sponge Puff</b><br/>                     4549738756439 / 4 pcs –<br/> <b>3.00 KD, 35.00 SAR/AED, 30.00 QR, 2.50 BD/OMR</b><br/>                     The sponge puff has adequate flexibility and is easy to use. It fits the skin well for even finish of makeup. The size fits into the MUJI ABS Foundation Case. When it gets dirt, use a sponge cleaner or neutral detergent to wash, rinse thoroughly and then hang to dry.</p> | <p><b>5-Sponge Puff For Liquid Foundation</b><br/>                     4549738756415-<br/> <b>3.00 KD, 35.00 SAR/AED, 30.00 QR, 2.50 BD/OMR</b><br/>                     The liquid does not soak easily into the puff, so the liquid foundation can be applied easily without waste.</p> | <p><b>6-Soft Sponge Puff</b><br/>                     4549738756422 –<br/> <b>1.75 KD, 25.00 SAR/AED, 20.00 QR, 2.00 BD/OMR</b><br/>                     The fluffy and smooth sponge contains natural moisturising component. The size fits into the MUJI ABS Foundation Case. When it gets dirty, use a sponge cleaner or neutral detergent to wash, rinse thoroughly and then hang to dry</p> |
| <p><b>8- Eye Colour Tip</b><br/>                     4550002868055 –<br/> <b>1.00 KD, 10.00 SAR/AED/QR, 1.25 BD/OMR</b></p>   | <p><b>9-Eye Colour Tip &amp; Brush</b><br/>                     4550002868062 / 2 pcs -<br/> <b>1.75 KD, 20.00 SAR/AED/QR, 2.00 BD/OMR</b></p>  | <p><b>7-Sponge Puff</b><br/>                     4550002868017 / 2 pcs -<br/> <b>1.25 KD, 1500 SAR/AED/QR, 1.50 BD/OMR</b></p>   |
|   |   | <p><b>10- Eyelash Curler</b><br/> <b>58 mm-</b> 4547315844449 –<br/> <b>3.00 KD/BD/OMR, 35.00 SAR/AED, 30.00 QR</b><br/> <b>104 mm-</b> 4547315844388 –<br/> <b>3.00 KD/BD/OMR, 35.00 SAR/AED, 30.00 QR</b></p>  |

## Cut Cotton & Cotton Buds



### 1-Cut Cotton Ecru

4549337318885 / 180 seet 60x50 mm  
Made with long, unbleached fibers which make them incredibly soft. Versatile cut cotton type.

2.00 KD, 25.00 SAR/AED,  
20.00 QR, 2.50 BD/OMR

### 2-Cut Cotton

4549337318908 / 165 seet 65x50 mm  
Made with long, unbleached fibers which make them incredibly soft. Versatile cut cotton type.

1.50 KD, 20.00 SAR/AED,  
15.00 QR, 2.00 BD/OMR

### 3-Cut Cotton Ecru/L

4549337318892 / 135 seet 90x70mm  
Large Cotton pads made from soft, unbleached cotton. These are made in Japan and made from 100% cotton.

2.50 KD, 35.00 SAR/AED,  
30.00 QR, 3.00 BD/OMR

### 4-Peelable Cotton

4549738743415 / 85x60mm  
Individually, these cotton pads can be split into four sheets. This makes them ideal for economic use or for use as a facemask, after having applied your product. Cotton 100%, 162 Sheets.

3.00 KD, 40.00 SAR/AED,  
35.00 QR, 4.00 BD/OMR

### 5-Cotton Puff

4549337318915 / 189 sheets 60x50mm

1.25 KD, 15.00 SAR/AED,  
12.00 QR, 1.50 BD/OMR

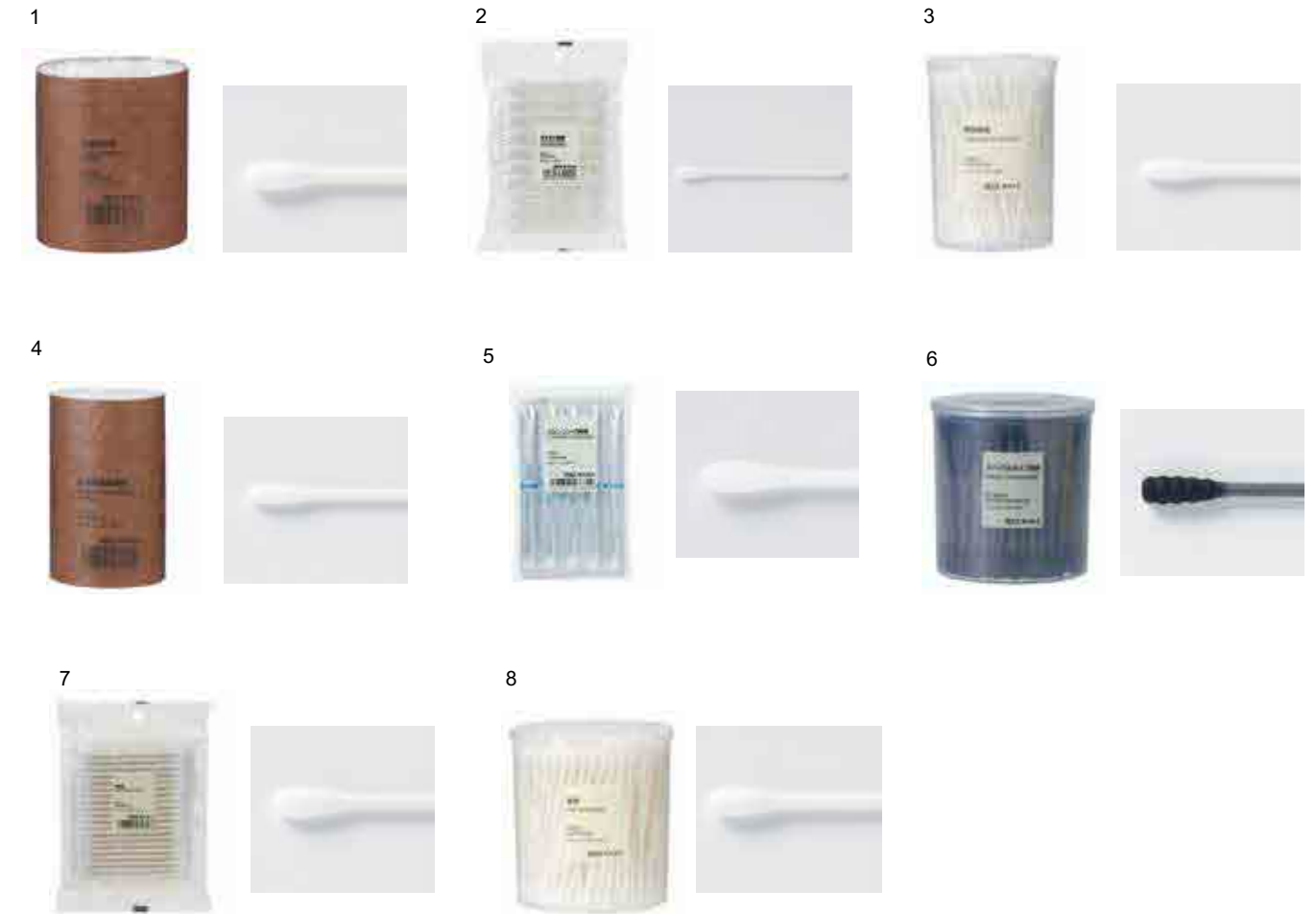

### 1-Cotton Buds Refill

4547315570386 / 200 pcs  
Cotton buds with 100% cotton tips and paper shafts. Sanitary due to chitosan antibacterial processing.

0.75 KD, 10.00 SAR/AED, 7.00 QR, 1.00 BD/OMR

### 2-Cotton Swab W/Ear Pick

4945247320992 / 50 pcs  
Cotton buds with ear pick on one side. Made with a supple paper shaft. Individually wrapped, making them sanitary and easily portable.

1.00 KD/BD/OMR 12.00 SAR/AED, 10.00 QR,

### 3-Thin Cotton Bud

4547315570362 / 200 pcs  
Made of 100% cotton, the cotton bud has a supple and ultra-thin paper shaft. It is sanitary due to chitosan antibacterial processing.

1.50 KD, 20.00 AED/SAR/QR, 2.00 BD/OMR

### 4-Thin Cotton Buds Refill

4547315570409 / 200 pcs  
Cotton buds with 100% cotton tips and paper shafts. Sanitary due to chitosan antibacterial processing. These thin type cotton buds are convenient for babies or for cleaning small places.

1.25 KD, 15.00 AED/SAR/QR,  
1.50 BD/OMR

### 5-Cleansing Cotton Buds

4547315276899 / 10 pcs  
The cotton bud is made of 100% cotton. The tip part contains cleanser, which can be used conveniently for touching up partial makeup. It is of individual package which is hygienic and portable.

1.50 KD, 20.00 AED/SAR,  
15.00 QR, 1.50 BD/OMR

### 6-Cotton Buds

4934761396705  
The black cotton bud shows up dirt clearly. It is sanitary due to chitosan antibacterial processing.

1.25 KD, 15.00 AED/SAR/QR,  
1.50 BD/OMR

### 7-Cotton Buds

4547315570393 / 80 pcs  
The cotton bud is made with 100% cotton and supple paper shaft. It is sanitary due to chitosan antibacterial processing.

0.60 KD, 10.00 AED/SAR,  
7.00 QR, 0.75 BD/OMR

### 8-Cotton Buds

4547315570379 / 200 pcs  
(SMALL ITEM) Made with 100% cotton, these cotton buds have a supple paper shaft. Sanitary due to chitosan antibacterial processing.

1.25 KD, 15.00 AED/SAR,  
10.00 QR, 1.50 BD/OMR



## Nylon Makeup Boxes

Nylon Makeup Boxes are compatible with PP Makeup Boxes, allowing easy assembly for a customised storage unit. The lid is specifically designed for storing makeup brushes, minimising the chance of cross-contamination. Small tools and items such as sewing accessories or first-aid kit tools can be stored in the boxes for easy transport.



Makeup Box L

4550002546403  
15.00 KD, 200.00 SAR/AED/QR,  
15.00 BD/OMR  
Grey



Makeup Box M

4550002546397  
12.00 KD, 150.00 SAR/AED/QR,  
12.00 BD/OMR  
Grey



Makeup Box S

4550002546380  
9.00 KD, 125.00 SAR/AED/QR,  
9.5 BD/OMR  
Grey



Makeup Box L

4550002546373  
15.00 KD, 200.00 SAR/AED/QR,  
15.00 BD/OMR  
Black



Makeup Box M

4550002547561  
12.00 KD, 150.00 SAR/AED/QR,  
12.00 BD/OMR  
Black



Makeup Box S

4550002547554  
9.00 KD, 125.00 SAR/AED/QR,  
9.5 BD/OMR  
Black



# Stationery



Pens

103



Notebooks

110



Arts & Crafts

113



Office Stationery

114



Frames

118



ABS Collection

119



## Stationery

Stationery for all! Whether you're preparing for a new school year, a new job, or just need to stock up on a few pens and pencils, you'll find it at MUJI! You can choose from a range of note books, sticky notes, sharpeners, scissors, organisers, calculators, digital clocks, office items, pen cases, pouches, files & file boxes, lunch boxes and backpacks.

We explore different materials and manufacturing methods in pursuit of the best form, without sacrificing affordability. We are always conscious of the end user's sense of satisfaction, even with a single pen. Our diverse range of stationery is here to support your life at home, study and at work. We have put together all essentials for the right start.

Classify contents and sort your notes easily with the Set of 5 Planting Tree Paper Note Books. MUJI stationery is designed so that everyone can use them regardless of age, occupation or personality.



**Pens**

MUJI pens provides consistent free flowing ink with a smooth glide that allows you to create beautiful consistent lines. Great for studying or adding a touch of colour to your artwork.



Polycarbonate Ball Point Pen / 0.7 mm 0.50KD, 7.00 AED/SAR/QR, 0.65 BD/OMR



Black 454871844434 Blue 4550002186579 Red 454871844441

Soft Calligraphy Pen 1.50KD, 15.00 AED/SAR/QR, 1.50 BD/OMR  
Brush tip is soft, is easy to write a brush pen.



Black 4548076007074

Hexagonal Water-Based Twin Pen  
A hexagonal twin pen that is easy to grip and write with.  
0.50KD, 7.00 AED/SAR/QR, 0.65 BD/OMR



Erasable Ball Point Pen 1.00KD, 15.00 AED/SAR/QR, 1.25 BD/OMR  
The cap of the pen can be used as an Eraser



Black 4549738649434 Blue 4549738649458 Green 4549738649489 Orange 4549738649472 Pink 4549738649465 Red 4549738649441



Yellow 4549337389816  
Red 4549337389786  
Purple 4549337389830  
Pink 4549337389922  
Lime 4549337389939  
Light blue 4549337389823  
Koubai 4549337389809  
Green 4549337389946  
Blue 4549337389793  
Black 4549337389779





## Marker sets



### Color pen Hexagonal

A set of 10 colours water colour pens.

4547315271573 3.00KD , 35.00 AED/SAR/QR ,  
4.00 BD/OMR



### Mini hexagonal color pen set

A set of 10 colours Water-based pen set

4548718963027 2.00KD , 25.00 AED/SAR,  
20.00 QR , 2.5 BD/OMR



### Hexagonal water based twin pen set

4550002186944

1.00KD , 12.00 AED/SAR/QR ,  
1.25 BD/OMR



### Pen Set 12 Colors With Case

Bargain set 12-colour twin pen.

4549337513686 4.00KD , 50.00 AED/SAR,  
40,00QR, 5.00 BD/OMR



Gel Ink Ballpoint Pen Cap Type **0.75KD , 10.00 AED/SAR/QR , 1.00 BD/OMR**

Gel Ink Ballpoint Pen series featuring universal design for easy-refilling. Cap Type Body is combined with 0.38mm Refill for Gel Ink Ballpoint Pen for writing small characters on journals and books.

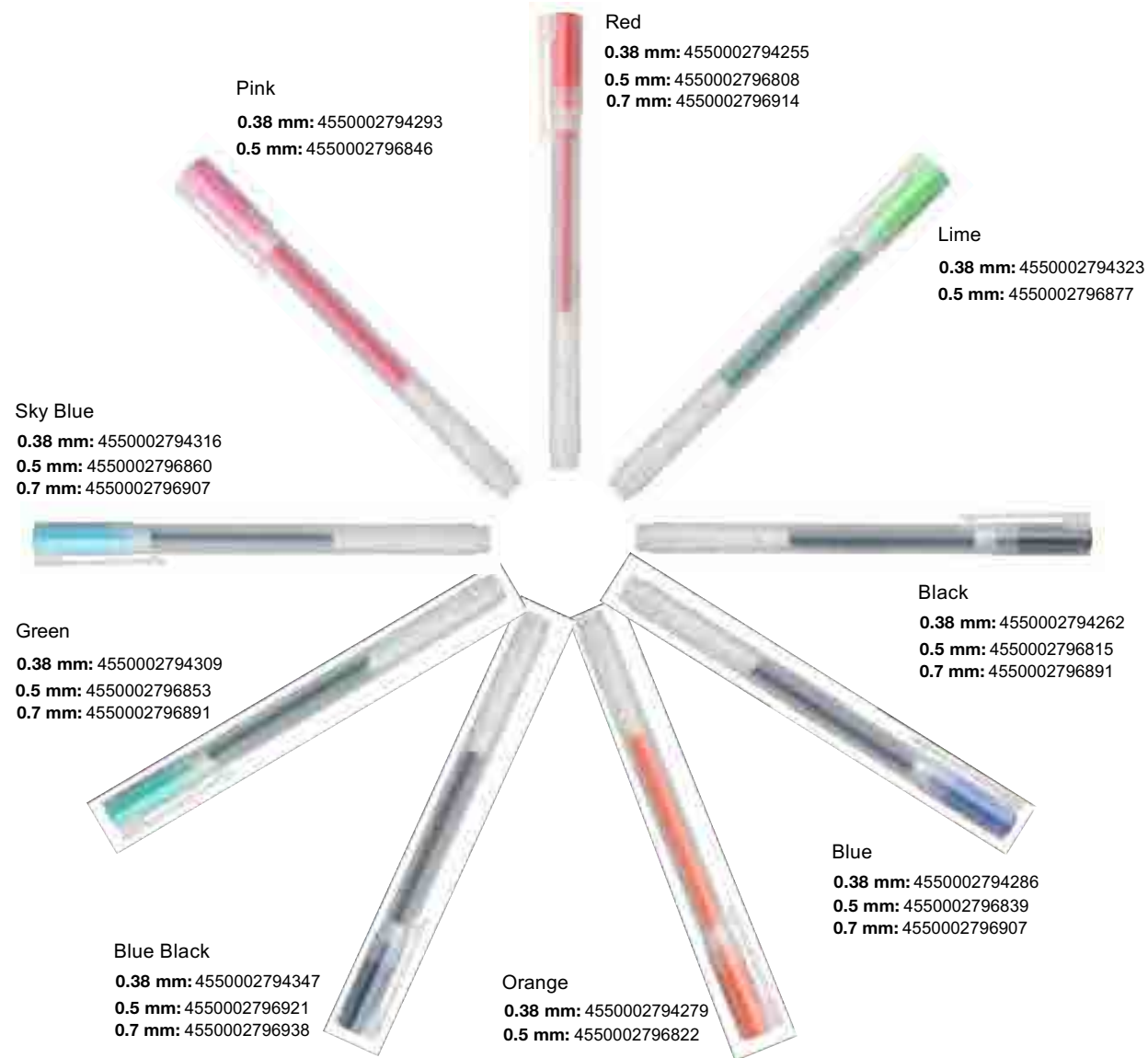

Gel Ink Pen Knock Type / 0.5 mm **0.75KD , 10.00 AED/SAR/QR , 1.00 BD/OMR**



0.38 mm



0.5 mm



0.7 mm





Highlighter Pen / Click Type **0.75KD , 10.00 AED/SAR/QR , 1.00 BD/OMR**

The push type highlighter pen can be used easily with one hand.

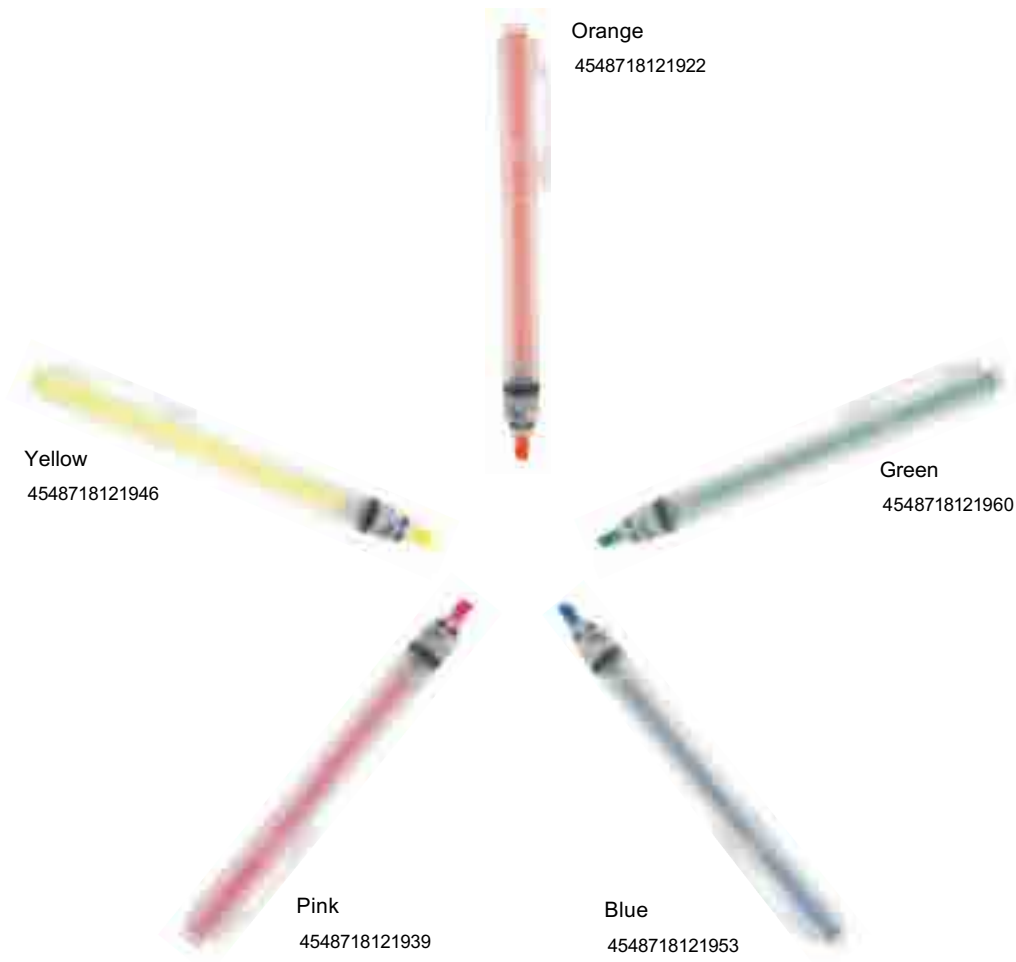

Orange  
4548718121922

Yellow  
4548718121946

Green  
4548718121960

Pink  
4548718121939

Blue  
4548718121953

Highlighter Pen With Window / Twin **0.50KD , 7.00 AED/SAR/QR , 0.65 BD/OMR**

Includes a small window at the tip of the pen. Easy marking highlighter pen.



Blue  
4548718654550

Green  
4548718654567

Pink  
4548718654536

Yellow  
4548718654543

Orange  
4548718654529

Notebooks

MUJI has an extensive range of stationery including a collection of notebooks and diaries. Designed specifically for your everyday needs, you will find notepads in sizes B6 to A4. So, whether you're jotting down your shopping list, sketching, studying or taking minutes, MUJI has a notepad ideal for the job. Also, many of MUJI's notebooks are made from recycled paper, making them environmentally friendly.



1-Planting Tree Paper Double Ring Notebook / Gray

- A5-4550002432850 | 48 sheet **0.75 KD ,10.00 AED/SAR/QR , 1.00 BD/OMR**
- A6-4550002433000 | 48 sheet **0.75 KD ,9.00 AED/SAR/QR , 0.75 BD/OMR**
- A7-4550002433055 | 48 sheet **0.50 KD , 7.00 AED/SAR/QR , 0.50 BD/OMR**
- B5-4550002432751 | 48 sheet **1.25KD , 15.00 AED/SAR/QR , 1.25 BD/OMR**



2-Planting Tree Paper Double Ring Notebook / Beige

- A5-4550002432805 | 48 sheet **0.75 KD ,10.00 AED/SAR/QR , 1.00 BD/OMR**
- A6-4550002432904 | 48 sheet **0.75 KD ,09.00 AED/SAR/QR , 0.75 BD/OMR**
- A7-4550002432959 | 48 sheet **0.50 KD ,7.00 AED/SAR/QR , 0.50 BD/OMR**
- B5-4550002432706 | 48 sheet **1.25 KD ,15.00 AED/SAR/QR , 1.25 BD/OMR**

3-Wirebound Notebook

- A5-4550182112313 | 80 sheet / 6mm **3.00 KD ,35.00 AED/SAR/QR , 3.75 BD/OMR**
- A6-4550182112412 | 80 sheet / 6mm **2.00 KD ,25.00 AED/SAR/QR , 2.50 BD/OMR**
- B6-4550182112368 | 80 sheet / 6mm **2.50 KD ,30.00AED/SAR/QR , 3.00 BD/OMR**



4-Planting Tree Paper Notebook 5Pcs/Set

- L-4548076316145 | B5 / 30 sheet / 6mm **2.25 KD ,25.00 AED/SAR , 18.00 QR , 3.00 BD/OMR**

**R - Paper Collection:**

**1-Double Ring Note Plain / Gray**

- A5-4550182109276 | 80 sheet – 1.50 KD, 20.00 SAR/AED/QR, 1.50 BD/OMR
- A6-4550182108675 | 80 sheet - 1.00 KD, 12.00 SAR/AED/QR, 1.25 BD/OMR
- B5-4550182109214 | 80 sheet – 1.75 KD, 25.00 SAR/AED/QR, 1.75 BD/OMR
- B6-4550182108613 | 80 sheet – 1.25 KD, 15.00 SAR/AED/QR, 1.5 BD/OMR



**2-Double Ring Note Plain / Beige**

- A5-4550182109399 | 80 sheet – 1.50 KD, 20.00 SAR/AED/QR, 1.50 BD.OMR
- A6-4550182108798 | 80 sheet - 1.00 KD, 12.00 SAR/AED/QR, 1.25 BD/OMR
- B5-4550182109337 | 80 sheet - 1.75 KD, 25.00 SAR/AED/QR, 1.75 BD/OMR
- B6-4550182108736 | 80 sheet - 1.25 KD, 15.00 SAR/AED/QR, 1.50 BD/OMR

**6-Double Ring Note Plain / Gray**

- A6-4550182108675 | 80 sheet- 1.00 KD, 12.00 SAR/AED/QR, 1.25 BD/OMR

- B6-4550182108613 | 80 sheet – 1.25 KD, 15.00 SAR/AED/QR, 1.50 BD/OMR

**7-Double Ring Note Plain / Beige**

- A6-4550182108798 | 80 sheet- 1.00 KD, 12.00 SAR/AED/QR, 1.25 BD/OMR

- B6-4550182108736 | 80 sheet – 1.25 KD, 15.00 SAR/AED/QR, 1.50 BD/OMR

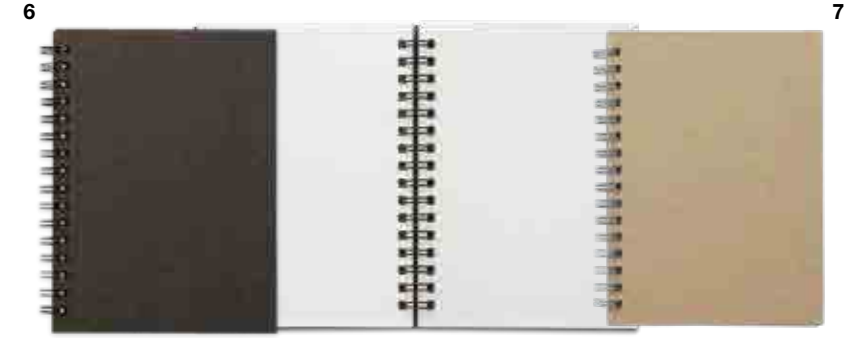

**3-Note Dot / Gray**

- A6-4550182108859 | 30 sheet / 5mm – 0.50 KD, 7.00 SAR/AED/QR, 0.50 BD/OMR
- A5-4550182108910 | 30 sheet / 5mm – 0.75 KD, 10.00 SAR/AED/QR, 0.75 BD/OMR
- B5-4550182108972 | 30 sheet / 5mm – 1.25 KD, 15.00 SAR/AED/QR, 1.25 BD/OMR



**4-Note Plain / Beige**

- A5-4550182109092 | 30 sheet / 5mm – 0.75 KD, 10.00 SAR/AED/QR, 0.75 BD/OMR
- A6-4550182109030 | 30 sheet / 5mm- 0.50 KD, 7.00 SAR/AED/QR, 0.50 BD/OMR
- B5-4550182109153 | 30 sheet / 5mm – 1.25 KD, 15.00 SAR/AED/QR, 1.25 BD/OMR

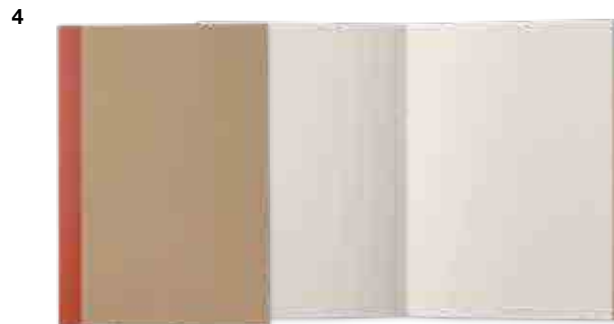

**8-Slim Notebook / Light Gray**

- A5-4550002434359 | 40 sheet – 1.00 KD, 15.00 SAR/AED/QR, 1.25 BD/OMR

- A6-4550002434403 | 40 sheet – 0.50 KD, 10.00 SAR/AED/QR, 0.75 BD/OMR

- B6-4550002474638 | 40 sheet – 0.75 KD, 12.00 SAR/AED/QR, 1.00 BD/OMR

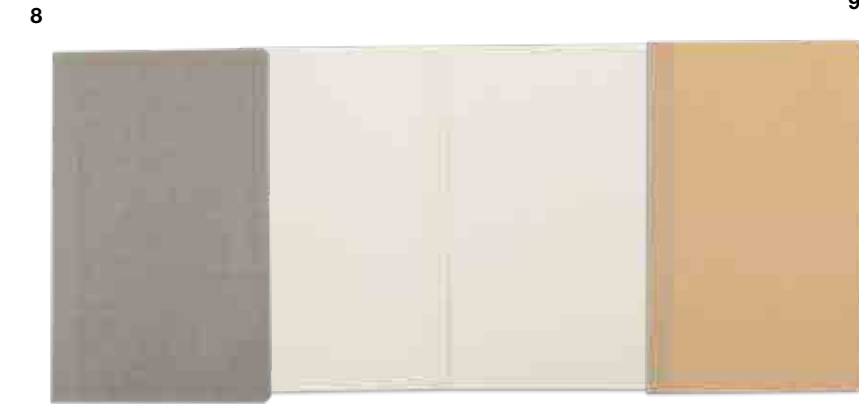

**9-Slim Notebook / Beige**

- A5-4550002434250 | 40 sheet – 1.00 KD, 15.00 SAR/AED/QR, 1.25 BD/OMR
- A6-4550002474584 | 40 sheet – 0.50 KD, 10.00 SAR/AED/QR, 0.75 BD/OMR
- B6-4550002434304 | 40 sheet – 0.75 KD, 12.00 SAR/AED/QR, 1.00 BD/OMR

1 1 1

**5-Ruled Notebook / Beige**

- A4-4550182109634 | 30 sheet / 7mm – 1.00 KD, 12.00 SAR/AED/QR, 1.25 BD/OMR
- A5-4550182109450 | 30 sheet / 6mm – 0.50 KD, 7.00 SAR/AED/QR, 0.50 BD/OMR
- A6-4550182109511 | 30 sheet / 6mm – 0.35 KD, 5.00 SAR/AED/QR, 0.35 BD/OMR
- B5-4550182109573 | 30 sheet / 6mm – 0.75 KD, 9.00 SAR/AED/QR, 0.75 BD/OMR





Arts and Crafts:



1-Sketch Book / F1  
4550182110975 | 20 sheet  
2.50 KD, 35.00 SAR/AED/QR,  
2.50 BD/OMR



2-Sketch Book / F4  
4550182111033 | 20 sheet  
3.50 KD, 45.00 SAR/AED/QR,  
3.75 BD/OMR



3-Sketch Book / PostCard Size  
4550182111095 | 20 sheet  
2.50 KD, 30.00 SAR/AED/QR,  
2.50 BD/OMR



4-Note Pad / B5  
4550182111163 | 80 sheet  
0.75 KD, 9.00 SAR/AED/QR,  
1.00 BD/OMR



5-Note Pad / B4  
4550182111170 | 40 sheet  
0.75 KD, 9.00 SAR/AED/QR,  
1.00 BD/OMR



6-Colour Pencil Sets / 60 colours  
4550002507619  
8.50 KD, 100.00 SAR/AED/QR,  
12.00 BD/OMR

7-Colour Pencil Sets / 12 colours  
4550002507916  
1.75 KD, 20.00 SAR/AED/QR,  
2.50 BD/OMR

8-Colour Pencil Sets / 36 colours / Half  
4550002507565  
3.75 KD, 45.00 SAR/AED/QR,  
5.00 BD/OMR

9-Colour Pencil Sets / 36 colours  
4550002507510  
5.00 KD, 60.00 SAR/AED/QR,  
6.50 BD/OMR

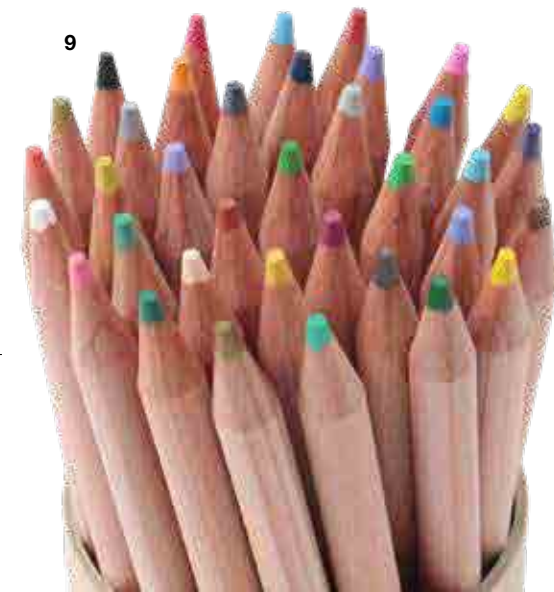

Office Stationery:



1-Calculator / 12Digit  
4549337355538 | W 10.4xD 17.3xH 1.2cm  
Solar powered or battery operated, battery  
supplied.  
4.25 KD, 50.00 SAR/AED/QR,  
6.00 BD/OMR



2-Digit Desk Calculator / 8Digit  
**Black-** 4548076151623 | 10.4 x 17.3 x  
1.5cm – 4.25 KD, 50.00 SAR/AED/QR,  
6.00 BD/OMR  
**Silver-** 4547315568086 | 6.9 x 11.5 x 7 cm  
Solar powered or battery operated, battery  
supplied. – 4.25 KD, 50.00 SAR/AED/QR,  
6.00 BD/OMR



3-Digit Calculator / 10Digit  
4547315007882  
Portable calculator with 10-digit display, easy  
to use with one hand  
4.00 KD, 45.00 SAR/AED/QR,  
5.50 BD/OMR



1-Masking Tape  
4550182188868  
0.50 KD, 7.00 SAR/AED/QR,  
0.75 BD/OMR



2-Masking Tape / Navy  
4549337516649 | 3 pack  
Use the navy patterned masking tape for  
wrapping or decorating.  
1.75 KD, 20.00 SAR/AED/QR,  
2.50 BD/OMR



3-Masking Tape  
4549337518865 | 3 pack  
Three-colour pack of masking tape can be  
used to spruce up wrappings, handmade  
albums and scrapbooks.  
1.75 KD, 20.00 SAR/AED/QR,  
2.50 BD/OMR



4-Masking Tape  
4548718957927 | 3 pack  
Use the red, beige and grey masking tape for  
wrapping or decorating. Each has  
approximately 12m of tape.  
1.75 KD, 20.00 SAR/AED/QR,  
2.50 BD/OMR



1 ABS Resin / Tape Dispenser  
4549738728917 | W 13.5 x L 3.7 x H 8.5 cm  
Easy operation with one hand, cellophane  
tape can be cut straight.  
4.00 KD, 45.00 SAR/AED/QR,  
5.00 BD/OMR



2 Acrylics Tape Dispenser  
4548076056386 | W 7.5 x L 2.3 x H 4.5 cm  
The dispenser is made of acrylic and is  
suitable for mini tape  
0.75 KD, 10.00 SAR/AED/QR,  
1.00 BD/OMR

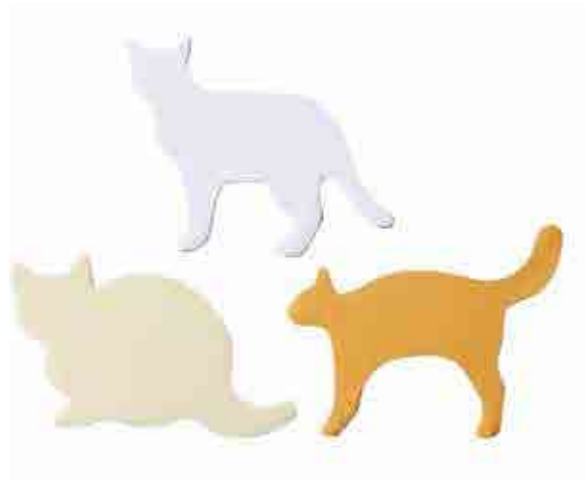

### 1-Planting Tree Paper Sticky Memo

4934761409566 | 3 kinds / 20sheet

Post-it that presents action of cats by silhouette..

1.25 KD, 15.00 SAR/AED/QR,  
1.75 BD/OMR

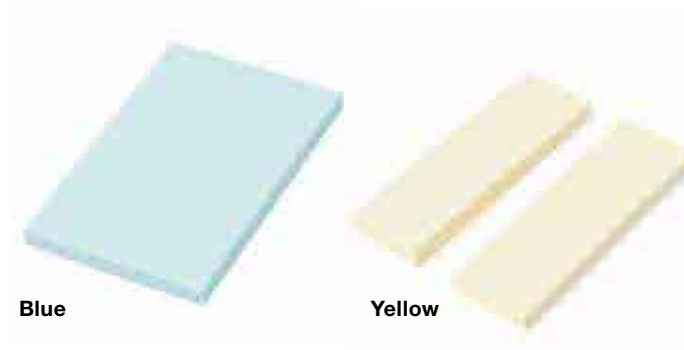

Blue

Yellow

### 2-Paper Sticky Note

Blue

75x25- 4550182111194 | 100sheet

75x50- 4550182111217 | 50 sheet

0.40 KD, 7.00 SAR/AED/QR,  
0.40 BD/OMR

Yellow

75x25- 4550182111187 | 100 sheet

75x50- 4550182111200 | 50 sheet

0.40 KD, 7.00 SAR/AED/QR,  
0.40 BD/OMR



### 3-Sticky Memo / 4 colours

5 pcs- 4548718962990 | 5 x 1.5 cm / 100 sheet

8 pcs- 4548718963003 | 3 x 1 cm / 100 sheet

Handy sized page signs for the office or study.

0.90 KD, 10.00 SAR/AED/QR,  
1.25 BD/OMR



### 4-Sticky Memo / 4 colours

4548718963010 | 100sheet

These sticky notes can also be used for indexing. Attach the sticker to the edge of the paper so you can easily find what you need.

0.90 KD, 10.00 SAR/AED/QR,  
1.25 BD/OMR

### 5-Sticky Pocket

1-Card size- 4550002185251 / 1 pocket - 2 sheets

0.60 KD, 7.00 SAR/AED/QR,  
0.80 BD/OMR

2-Post card size- 4550002185268 / 1 sheets

0.90 KD, 10.00 SAR/AED/QR,  
1.25 BD/OMR

Adhesive seal type pockets that can be stuck into a diary or notebook. For storing postcards, business cards, notes etc.

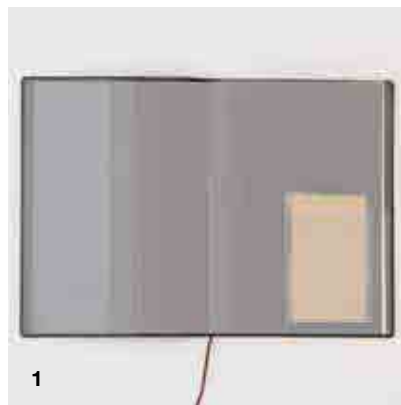

1

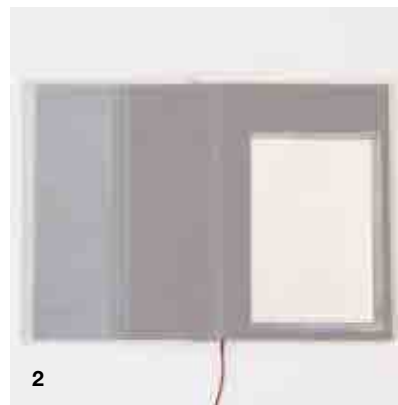

2



### 6-Sticky Note / Weekly Planner

4550002185435 | 13 sheets

Free-type weekly planner allowing you to fill in the dates yourself, now with sticky notes.

0.60 KD, 7.00 SAR/AED/QR,  
0.65 BD/OMR



### 7-Sticky Note / Monthly Planner

4550002185428 | 13 sheets

Sticky note with monthly schedule that you can fill in the date freely.

0.60 KD, 7.00 SAR/AED/QR,  
0.65 BD/OMR



### 8- Recycled Paper Sticky Note

4550002185312 | 100 sheets / 7.5 x 2.5 cm

Sticky note made of craft paper. It can be inserted into a notebook or a schedule book to take notes flexibly.

0.60 KD, 7.00 SAR/AED/QR,  
0.65 BD/OMR



### 9- Recycled Paper Sticky Note

4550002185299 | 30 sheets / 7.5 x 7.5 cm

Sticky note made of craft paper. It can be inserted into a notebook or a schedule book to take notes flexibly.

0.60 KD, 7.00 SAR/AED/QR,  
0.65 BD/OMR



### 10- Recycled Paper Sticky Note

4550002185305 | 50 sheets / 7.5 x 5 cm

Sticky note made of craft paper. It can be inserted into a notebook or a schedule book to take notes flexibly.

0.60 KD, 7.00 SAR/AED/QR,  
0.65 BD/OMR

### 4-Sticky Checklist / 3 colours

4550002185459 | 10 sheets

Index for identifying the location of sticky notes in notebook or schedule book.

1.00 KD, 12.00 SAR/AED/QR,  
1.25 BD/OMR

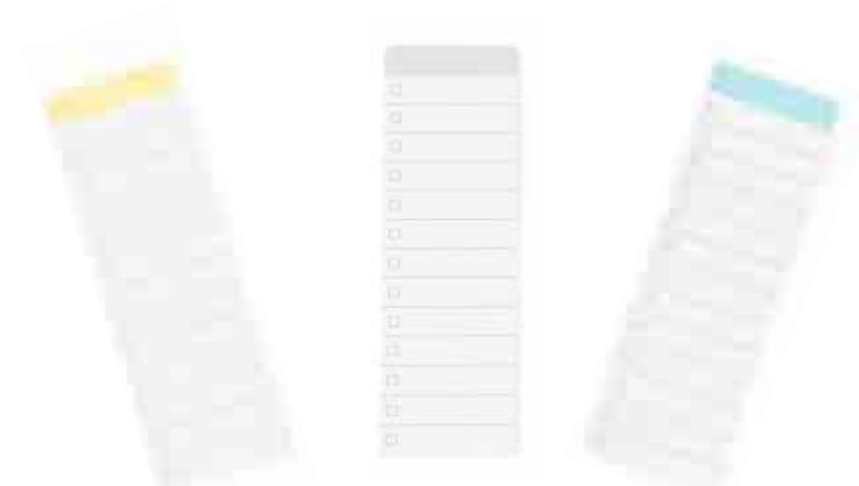





1-Plastic Eraser

White

L- 4945247421330- **0.35 KD, 5.00 SAR/AED/QR, 0.50 BD/OMR**

S- 4945247421323- **0.25 KD, 3.00 SAR/AED/QR, 0.35 BD/OMR**

Black

L- 4945247421354- **0.35 KD, 5.00 SAR/AED/QR, 0.50 BD/OMR**

S- 4945247421347- **0.25 KD, 3.00 SAR/AED/QR, 0.35 BD/OMR**

An eraser using non-vinyl chloride material.



Stainless Pen Holder

**1 pc-** 4934761183732 – **1.50 KD, 15.00 SAR/AED/QR, 2.00 BD/OMR**

**2 pcs-** 4934761183749 – **2.25 KD, 25.00 SAR/AED/QR, 3.00 BD/OMR**

It can be used with notebook and schedule books. Carrying a pen becomes easier.



4-Nylon Pen Case

4549738308065 / Black

It can store a lot of stationery and small sized office supplies. There is a simple mesh pocket inside.

**3.00 KD, 35.00 SAR/AED/QR, 4.00 BD/OMR**



2-Handy Shredder

4549738915430 | W 18.2x D 5 x H 3cm

Compact handy shredder can be stored vertically without taking much space.

**3.50 KD, 45.00 SAR/AED, 40.00 QR,**

**4.00 BD/OMR**



4-Nylon Card Case With Reel

4547315251063

It is a lanyard with with reel which can scan ID card easily. You can take it out immediately if you attach it to the holder of the bag with the strap. Strap portion about 20 cm, the longest reel portion about 51 cm

**3.25 KD, 40.00 SAR/AED/QR, 4.25 BD/OMR**

Frames:



1-Acrylic Frame / Standing Type

**A4-** 4934761479712 – **6.00 KD, 80.00 SAR/AED, 75.00 QR, 7.50 BD/OMR**

**10.0 x 14.8MM-** 4934761688411- **2.75 KD, 35.00 SAR/AED, 30.00 QR, 3.50 BD/OMR**

**A5-** 4934761479729 – **4.50 KD, 60.00 SAR/AED, 55.00 QR, 5.50 BD/OMR**

**8.9 x 12.7 MM-** 4934761479736 – **2.00 KD, 30.00 SAR/AED, 25.00 QR, 2.50 BD/OMR**

Simple structure which is composed of 2 pieces of acrylic boards. Possible to place either vertically or horizontally depending on the way of installing the legs.



Acrylic Frame / SType

**A3-** 4945247913637- **11.00 KD, 130.00 SAR/AED, 125.00 QR, 14.00 BD/OMR**

**A4-** 4945247913644- **9.00 KD, 120.00 SAR/AED, 115.00 QR, 12.00 BD/OMR**

**B3-** 4945247913620- **11.00 KD, 135.00 SAR/AED, 130.00 QR, 14.00 BD/OMR**

Use the transparent acrylic board as it is.

Acrylic Twin Frame

4934761479750 / 8.9x12.7 cm

Using simple structure with acrylic board that is not easy to break.

**1.75 KD, 25.00 SAR/AED, 20.00 QR, 2.50 BD/OMR**

Magnetic Frame

**S-** 4547315014606 / 8.8 x 2.4 x 11.4 cm-

**3.50 KD, 40.00 SAR/AED, 35 QR, 4.00 BD/OMR**

**M-** 4550002571214 / 11.4 x 2.4 x 15.0cm-

**4.50 KD, 50.00 SAR/AED/QR, 5.50 BD/OMR**

**L-** 4550002571221 / 12.7 x 3.0 x 17cm-

**5.50 KD, 60.00 SAR/AED/QR, 7.00 BD/OMR**

**XL-** 4550002571238 / 15.0 x 3.0 x 20.1cm-

**7.50 KD, 80.00 SAR/AED/QR, 9.50 BD/OMR**

**Landscape-** 4550002571245 –

**6.50 KD, 70.00 SAR/AED/QR, 8.00 BD/OMR / 12.0 x 24 x 27.3cm**

Unobtrusive acrylic frames are designed to ensure the focus is on the picture and not on the frame. These frames can be used either landscape or portrait.

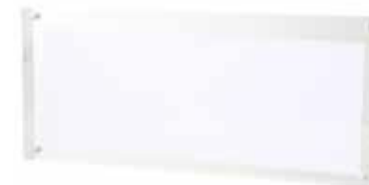

**ABS Collection:**

14 storage units are available for flexible combination, allowing you to create your own desktop storage system that fits your needs.

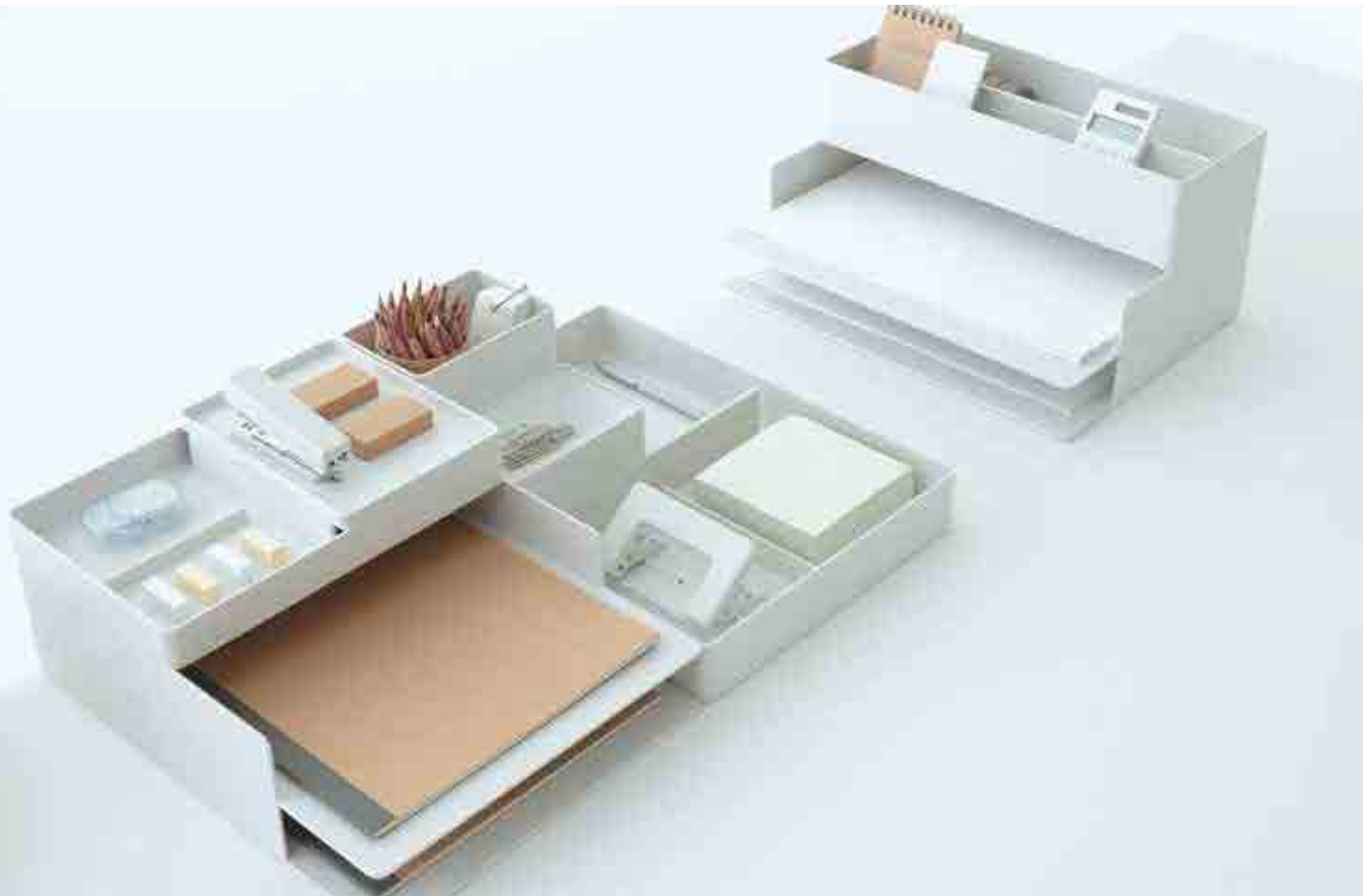

**ABS Tray Stand Type**  
**A4- 4549337328587 – 6.60 KD, 75.00 SAR/AED, 70.00 QR, 9.00 BD/OMR**  
**A5- 4549337328945 – 4.00 KD, 45.00 SAR/AED, 40.00 QR, 5.00 BD/OMR**  
 The tray that can be used as a shelf with legs. It can be used with trays of the same series as a unit. Maximum Stacking Levels: 2 levels



**ABS Resin / Organising Tray 1/8**  
**A7 – 4549738728818**  
 This ABS Tray with partition can be stacked with same series of trays. Maximum Stacking Levels: up to 3 levels Weight Capacity: 9 kg  
**1.75 KD, 20.00 SAR/AED/QR, 2.50 BD/OMR**



**ABS Resin / Key / Coin Tray 1/8**  
**A7 – 4549738728801**  
 The tray inverted inward that can be used with trays of the same series as a unit. Maximum Stacking Levels: 3 levels / Weight Capacity: 9kg  
**1.75 KD, 20.00 SAR/AED/QR, 2.50 BD/OMR**



**ABS Resin / Tray**  
**A6- 4549738728825- 1.25 KD, 15.00 SAR/AED/QR, 1.50 BD/OMR**  
**A7- 4549738728832- 1.00 KD, 10.00 SAR/AED/QR, 1.25 BD/OMR**  
 Stackable with other trays in the same series as a lid.



**ABS Resin / Half Organiser Box**  
**A4 – 4549738728788**  
**6.00 KD, 70.00 SAR/AED/QR, 7.50 BD/OMR**



**ABS Resin / Box**  
**A7 - 4549738728795**  
 It is a partition where writing implements, and small office items can be placed. It can be attached to and used with trays from the same series.  
**2.50 KD, 30.00 SAR/AED/QR, 3.25 BD/OMR**



**ABS Document Tray**  
**A4- 4549337328594**  
 It is a convenient tray for organising documents. It can be used in combination with trays of the same series. Maximum withstand load: 9kg Maximum number of layers when stacking: 3 layers.  
**5.50 KD, 65.00 SAR/AED, 60.00 QR, 7.00 BD/OMR**



**ABS Resin / Horizontal**  
**A4 - 4549738728771**  
 It is a convenient tray for organising documents. It can be used in combination with trays of the same series. Maximum withstand load: 9kg Maximum number of layers when stacking: 3 layers.  
**6.00 KD, 70.00 SAR/AED/QR, 7.50 BD/OMR**



**ABS Tray A4**  
**A4 – 4549337328600- 6.00 KD, 65.00 SAR/AED, 60.00 QR, 8.00 BD/OMR**  
**A5 – 4549337328617- 4.00 KD, 45.00 SAR/AED, 40.00 QR, 5.00 BD/OMR**  
**A6 – 4549337328891– 3.00 KD, 35.00 SAR/AED, 30.00 QR, 4.00 BD/OMR**  
 A tray with internal dividers for extra organisation. Stack up to 3 trays to create your own filing system and use in combination with other ABS storage.



**ABS Pen Stand**  
 4549337328938 / 8.1 x 11 cm  
 The stand with partition is convenient to arrange writing tools and small office accessories. It can be used in combination with trays of the same series  
**3.00 KD, 35.00 SAR/AED, 30.00 QR, 4.00 BD/OMR**





Fashion



Men's wear

124



Ladies wear

129



Children's wear

139



Pajamas

145

Mens Wear



Shirts & T-Shirts



SLUB JERSEY STITCH V NECK S/S T-SHIRT

Style No. ABA0420S  
 8.00 KD,100.00 QR/SAR/AED, 10.00 BD/OMR  
 S, M, L, XL  
 Colors:



XINJIANG COTTON PIQUE S/S T-SHIRT

Style No. ABA0720S  
 8.00 KD,100.00 QR/SAR/AED, 10.00 BD/OMR  
 S, M, L, XL  
 Colors:

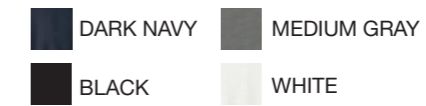

INDIAN COTTON JERSEY STITCH BORDER S/S T-SHIRT

Style No. ABB0120S  
 5.00 KD, 60.00 SAR/AED, 50.00 QR, 6.00 BD/OMR  
 S, M, L, XL, L, XXL  
 Colors:

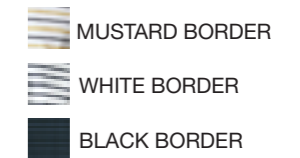

SLUB JERSEY STITCH BORDER S/S T-SHIRT

Style No. ABB0420S  
 8.00 KD,100.00 QR/SAR/AED, 10.00 BD/OMR  
 S, M, L, XL, L, XXL  
 Colors:

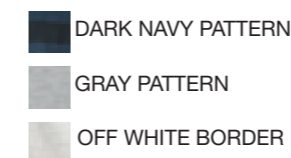

XINJIANG COTTON PIQUE S/S T-SHIRT

Style No. ABE0220S  
 8.00 KD, 99.00 QR/SAR/AED, 10.00 BD/OMR  
 S, M, L, XL, L, XXL  
 Colors:

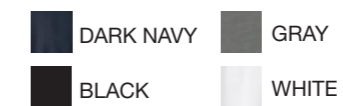

XINJIANG COTTON PIQUE BORDER S/S POLO SHIRT

Style No. ABF0120S  
 8.00 KD, 99.00 QR/SAR/AED, 10.00 BD/OMR  
 S, M, L, XL, L, XXL  
 Colors:

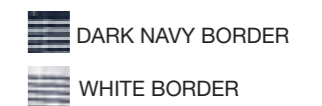





SLUB JERSEY STITCH V NECK S/S T-SHIRT

Style No. ACA0920S

14.00 KD, 175.00 QR/SAR/AED, 18.00 BD/OMR

S, M, L, XL

Colors:

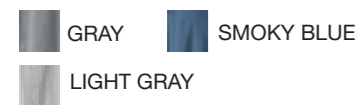

EXTRA LONG STAPLE COTTON WASHED BROAD STAND COLLAR SHIRT

Style No. ACA1020S

14.00 KD, 175.00 QR/SAR/AED, 18.00 BD/OMR

S, M, L, XL

Colors:



INDIAN COTTON DOUBLE GAUZE STAND COLLAR SHIRT

Style No. ACA2020S

14.00 KD, 175.00 QR/SAR/AED, 18.00 BD/OMR

S, M, L, XL

Colors:

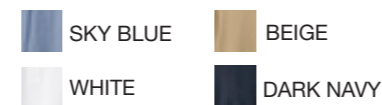

OGC CREW NECK S/S T SHIRT

Style No. D9SB233

5.00 KD, 50.00 QR, 60.00 SAR/AED, 6.00 BD/OMR

XS, S, M, L, XL, XXL

Colors:



OGC V NECK S/S T SHIRT

Style No. D9SB234

5.00 KD, 50.00 QR, 60.00 SAR/AED, 6.00 BD/OMR

XS, S, M, L, XL, XXL

Colors:



INDIAN COTTON JERSEY STITCH CREW NECK S/S T-SHIRT

Style No. ABA0120S

5.00 KD, 50.00 QR, 60.00 SAR/AED, 6.00 BD/OMR

XS, S, M, L, XL, XXL

Colors:

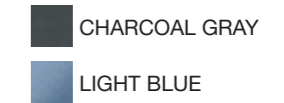

INDIAN COTTON DOUBLE GAUZE SHIRT

Style No. ACA2220S

14.00 KD, 160.00 QR/SAR/AED, 16.00 BD/OMR

S, M, L, XL

Colors:



INDIAN COTTON INDIGO DOUBLE GAUZE SHIRT

Style No. ACA2320S

14.00 KD, 160.00 QR/SAR/AED, 16.00 BD/OMR

S, M, L, XL

Colors:



FRENCH LINEN WASHED STAND COLLAR SHIRT

Style No. ACA3020S

8.00 KD, 99.00 QR/SAR/AED, 10.00 BD/OMR

S, M, L, XL

Colors:

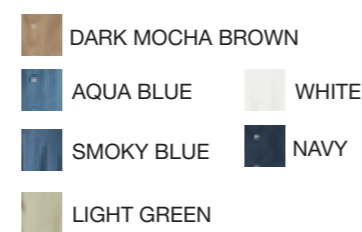

INDIAN COTTON JERSEY STITCH V NECK S/S T-SHIRT

Style No. ABA0220S

5.00 KD, 50.00 QR, 60.00 SAR/AED, 6.00 BD/OMR

XS, S, M, L, XL, XXL

Colors:

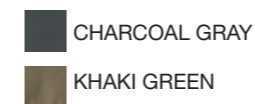

FRENCH LINEN WASHED SHIRT

Style No. ACA3120S

18.00 KD, 225.00 QR/SAR/AED, 22.00 BD/OMR

S, M, L, XL

Colors:



FRENCH LINEN WASHED S/S SHIRT

Style No. ACC3120S

18.00 KD, 225.00 QR/SAR/AED, 22.00 BD/OMR

S, M, L, XL

Colors:

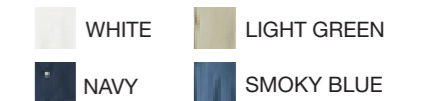

## Shorts & Pants



INDIAN COTTON BROAD SHORTS

Style No. AED1420S

12.00 KD, 150.00 QR/SAR/AED, 15.00 BD/OMR

S, M, L, XL

Colors:

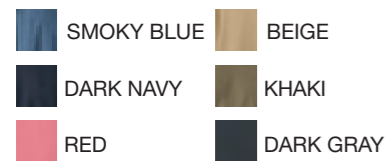

FRENCH LINEN TROUSERS

Style No. AEH0920S

20.00 KD, 250.00 QR/SAR/AED, 25.00 BD/OMR

S, M, L, XL

Colors:

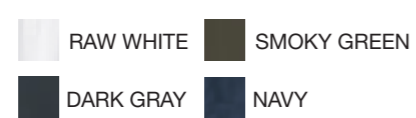

INDIAN COTTON BROAD SHORTS

Style No. D9AE514

12.00 KD, 150.00 QR/SAR/AED, 15.00 BD/OMR

S, M, L, XL

Colors:



FRENCH LINEN SHORTS

Style No. AED1920S

17.00 KD, 210.00 QR/SAR/AED, 21.00 BD/OMR

S, M, L, XL

Colors:





Ladies Wear



Tops



UV PROTECTION FRENCH LINEN WIDE CARDIGAN

Style No. BAD7120S  
20.00 KD, 250.00 QR/SAR/AED, 25.00 BD/OMR  
XS-S, M-L  
Colors:



UV PROTECTION STRONG TWISTED LONG CARDIGAN

Style No. BAD7320S  
15.00 KD, 180.00 QR/SAR/AED, 18.00 BD/OMR  
XS-S, M-L  
Colors:

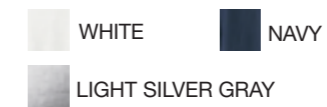

COTTON RAYON DOLMAN T-SHIRT

Style No. BBA1620S  
10.00 KD, 120.00 QR/SAR/AED, 12.00 BD/OMR  
XS-S, M-L  
Colors:

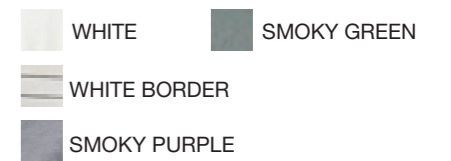

COTTON RAYON WIDE PANTS

Style No. BBI0120S  
12.00 KD, 150.00 QR/SAR/AED, 15.00 BD/OMR  
XS-S, M-L  
Colors:

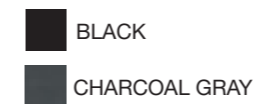

ADJUSTABLE PULL OVER

Style No. BBT01A0S  
14.00 KD, 175.00 QR/SAR/AED, 18.00 BD/OMR  
One size  
Colors:

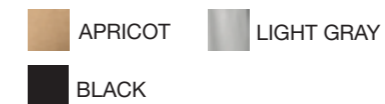

ADJUSTABLE TUNIC

Style No. BBT02A0S  
16.00 KD, 200.00 QR/SAR/AED, 20.00 BD/OMR  
One size  
Colors:





ORGANIC LINEN WASHED 3/4 SLEEVE BLOUSE

Style No. BCA0120S  
17.00 KD, 210.00 QR/SAR/AED, 21.00 BD/OMR  
XS, S, M, L  
Colors:



UV PROTECTION STRONG TWISTED LONG CARDIGAN

Style No. BCA0220S  
17.00 KD, 210.00 QR/SAR/AED, 21.00 BD/OMR  
XS-S, M-L  
Colors:

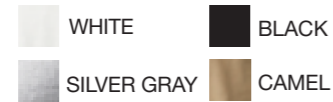

ORGANIC LINEN WASHED FRENCH SLEEVE BLOUSE

Style No. BCA0320S  
17.00 KD, 210.00 QR/SAR/AED, 21.00 BD/OMR  
XS-S, M-L  
Colors:



INDIAN COTTON DOUBLE GAUZE TUNIC

Style No. BCJ0120S  
16.00 KD, 200.00 QR/SAR/AED, 20.00 BD/OMR  
XS-S, M-L  
Colors:



FRENCH LINEN WASHED TUNIC

Style No. BCJ0220S  
17.00 KD, 210.00 QR/SAR/AED, 21.00 BD/OMR  
XS-S, M-L  
Colors:

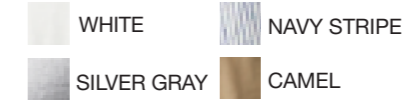

INDIAN COTTON DOUBLE GAUGE TUNIC

Style No. BCJ0320S  
17.00 KD, 210.00 QR/SAR/AED, 21.00 BD/OMR  
XS-S, M-L  
Colors:



XINJIANG COTTON WASHED BROAD 3/4 SLEEVE BLOUSE

Style No. BCA0420S  
14.00 KD, 160.00 QR/SAR/AED, 16.00 BD/OMR  
XS, S, M, L  
Colors:



ORGANIC LINEN WASHED SHIRT

Style No. BCB0720S  
17.00 KD, 210.00 QR/SAR/AED, 21.00 BD/OMR  
XS, S, M, L  
Colors:



ORGANIC LINEN WASHED STAND COLLAR SHIRT

Style No. BCB0820S  
17.00 KD, 210.00 QR/SAR/AED, 21.00 BD/OMR  
XS, S, M, L  
Colors:

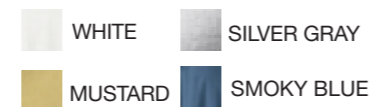

XINJIANG COTTON JERSEY COMBINATION STAND COLLAR TUNIC

Style No. BCM04A0S  
17.00 KD, 210.00 QR/SAR/AED, 21.00 BD/OMR  
One size  
Colors:

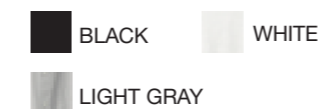

LYOCELL MIX DENIM WIDE SHIRT

Style No. BCM02A0S  
16.00 KD, 200.00 QR/SAR/AED, 20.00 BD/OMR  
One size  
Colors:



LYOCELL WIDE SHIRT

Style No. BCM06A0S  
16.00 KD, 200.00 QR/SAR/AED, 20.00 BD/OMR  
One size  
Colors:

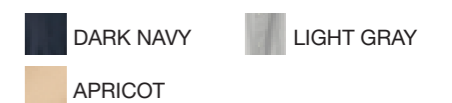



## Dresses







INDIAN COTTON INDIGO DOUBLE GAUZE STAND COLLAR DRESS

Style No. BCL0120S  
 20.00 KD, 250.00 QR/SAR/AED, 25.00 BD/OMR  
 XS-S, M-L  
 Colors:  
 NAVY



FRENCH LINEN WASHED STAND COLLAR DRESS

Style No. BCL0520S  
 20.00 KD, 250.00 QR/SAR/AED, 25.00 BD/OMR  
 XS, S, M, L  
 Colors:  
 RAW WHITE  
 DARK NAVY STRIPE  
 DARK MOCHA BROWN  
 CHARCOAL GRAY



FRENCH LINEN WASHED 3/4 SLEEVE DRESS

Style No. BCL0620S  
 20.00 KD, 250.00 QR/SAR/AED, 25.00 BD/OMR  
 XS, S, M, L  
 Colors:  
 KHAKI BEIGE  DARK GRAY  
 DARK GRAY  GRAY





FRENCH LINEN WASHED SLEEVELESS DRESS

Style No. BCL0720S  
 20.00 KD, 250.00 QR/SAR/AED, 25.00 BD/OMR  
 XS, S, M, L  
 Colors:  
 BLACK  DARK BROWN  
 DARK MOCHA BROWN





FRENCH LINEN WASHED S/S DRESS

Style No. BCL0820S  
 20.00 KD, 250.00 QR/SAR/AED, 25.00 BD/OMR  
 XS-S, M-L  
 Colors:  
 BLACK  
 SILVER GRAY  
 MOCHA BROWN



INDIAN COTTON DOUBLE GAUZE CREW NECK DRESS

Style No. BCL1020S  
 20.00 KD, 250.00 QR/SAR/AED, 25.00 BD/OMR  
 XS-S, M-L  
 Colors:  
 CHARCOAL GRAY  
 DARK NAVY





LYOCELL MIX DENIM DRESS

Style No. BCM01A0S  
 20.00 KD, 250.00 QR/SAR/AED, 25.00 BD/OMR  
 One size  
 Colors:  
 NAVY





XINJIANG COTTON JERSEY COMBINATION DRESS

Style No. BCM03A0S  
 22.00 KD, 275.00 QR/SAR/AED, 28.00 BD/OMR  
 One size  
 Colors:  
 BLACK  DARK GRAY





LYOCELL DRESS

Style No. BCM05A0S  
 20.00 KD, 250.00 QR/SAR/AED, 25.00 BD/OMR  
 One size  
 Colors:  
 DARK GRAY  
 DARK NAVY



FRENCH LINEN COAT

Style No. BDE0320S  
 27.00 KD, 325.00 QR/SAR/AED, 32.00 BD/OMR  
 XS-S, M-L  
 Colors:  
 PALE BROWN  DARK GRAY  
 DARK MOCHA BROWN

## Skirts & Pants



FRENCH LINEN FLAIR SKIRT

Style No. BEK0320S  
 20.00 KD, 250.00 QR/SAR/AED, 25.00 BD/OMR  
 XS, S, M, L  
 Colors:  
 DARK NAVY KHAKI BEIGE  
 MUSTARD



XINJIANG COTTON JERSEY COMBINATION STAND COLLAR TUNIC

Style No. BEK0720S  
 20.00 KD, 250.00 QR/SAR/AED, 25.00 BD/OMR  
 XS, S, M, L  
 Colors:  
 CAMEL NAVY STRIPE  
 SMOKY ORANGE  
 DARK NAVY



COTTON RAYON DOLMAN SLEEVE PULLOVER

Style No. L9AA830  
 16.00 KD, 200.00 QR/SAR/AED, 20.00 BD/OMR  
 XS-S, M-L  
 Colors:  
 LIGHT GRAY BLACK  
 GRAYISH BROWN



COTTON RAYON WIDE DOLMAN T-SHIRT

Style No. L9AB049  
 10.00 KD, 120.00 QR/SAR/AED, 12.00 BD/OMR  
 XS-S, M-L  
 Colors:  
 CHARCOAL GRAY BLACK  
 DARK BROWN GREEN



COTTON LYOCELL GATHERED NECK BLOUSE

Style No. L9AC208  
 12.00 KD, 150.00 QR/SAR/AED, 15.00 BD/OMR  
 XS-S, M-L  
 Colors:  
 WHITE DARK BROWN  
 SILVER GRAY



LYOCELL EASY WIDE TAPERED CROPPED PANTS

Style No. L9AE236  
 16.00 KD, 200.00 QR/SAR/AED, 20.00 BD/OMR  
 S, M, L  
 Colors:  
 DARK GRAY BLACK  
 CHARCOAL GRAY



COTTON RAYON GARTER STITCH S/S PULLOVER

Style No. L9AA831  
 14.00 KD, 175.00 QR/SAR/AED, 18.00 BD/OMR  
 XS-S, M-L  
 Colors:  
 LIGHT GRAY BLACK  
 GRAYISH BROWN



COTTON RAYON 3/4 SLEEVE TUCK PULLOVER

Style No. L9AB025  
 10.00 KD, 120.00 QR/SAR/AED, 12.00 BD/OMR  
 XS-S, M-L  
 Colors:  
 BLACK WHITE  
 DARK BROWN



COTTON RAYON HALF SLEEVE DRESS

Style No. L9AB030  
 16.00 KD, 200.00 QR/SAR/AED, 20.00 BD/OMR  
 XS-S, M-L  
 Colors:  
 BLACK  
 CHARCOAL GRAY  
 IVORY BORDER



INDIAN COTTON DENIM EASY TAPERED PANTS

Style No. L9AE903  
 17.00 KD, 210.00 QR/SAR/AED, 21.00 BD/OMR  
 One size  
 Colors:  
 NAVY



INDIAN COTTON DENIM EASY WIDE PANTS

Style No. L9AE904  
 17.00 KD, 210.00 QR/SAR/AED, 21.00 BD/OMR  
 One size  
 Colors:  
 NAVY



QUICK DRY 4 WAY STRETCH EASY TAPERED PANTS

Style No. L9AE905  
 16.00 KD, 200.00 QR/SAR/AED, 20.00 BD/OMR  
 One size  
 Colors:  
 BLACK





QUICK DRY 4 WAY STRETCH EASY  
WIDE PANTS

Style No. L9AE906  
16.00 KD, 200.00 QR/SAR/AED, 20.00 BD/OMR  
One size  
Colors:  
■ BLACK



STRETCH BRUSHED TAPERED PANTS

Style No. L9AE909  
15.00 KD, 225.00 QR/SAR/AED, 22.00 BD/OMR  
One size  
Colors:  
■ BLACK



STRETCH BRUSHED WIDE PANTS

Style No. L9AE910  
18.00 KD, 225.00 QR/SAR/AED, 22.00 BD/OMR  
S, M, L  
Colors:  
■ BLACK



QUICK DRY 4 WAY STRETCH EASY  
TAPERED PANTS

Style No. BE11220S  
16.00 KD, 200.00 QR/SAR/AED, 20.00 BD/OMR  
XS, S, M, L  
Colors:  
■ BLACK ■ NAVY



QUICK DRY 4 WAY STRETCH EASY  
WIDE PANTS

Style No. BE11320S  
16.00 KD, 200.00 QR/SAR/AED, 20.00 BD/OMR  
XS, S, M, L  
Colors:  
■ BLACK ■ NAVY

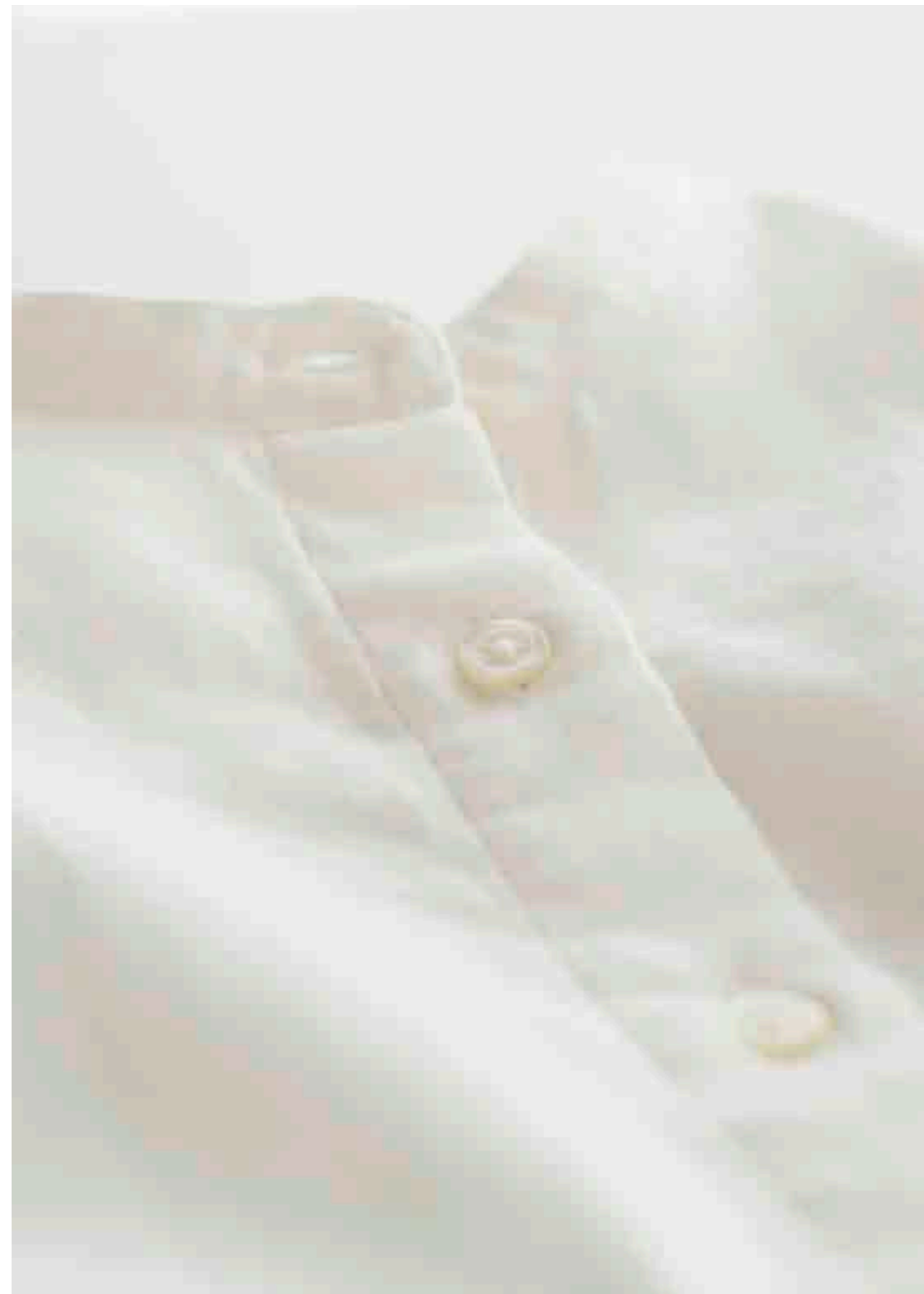

Children's Wear



INDIAN COTTON JERSEY S/S T-SHIRT (KIDS)

Style No. CBF01A0S  
 3.00 KD, 40.00 QR/SAR/AED, 4.00 BD/OMR  
 110, 120, 130  
 Colors:

 LIGHT SILVER GRAY



INDIAN COTTON JERSEY DOT S/S TSHIRT (KIDS)

Style No. CBF03A0S  
 3.00 KD, 40.00 QR/SAR/AED, 4.00 BD/OMR  
 110, 120, 130  
 Colors:

 PINK  NAVY  
 OFF WHITE



SLUB DROP SHOULDER S/S TSHIRT (KIDS)

Style No. CBF11A0S  
 4.00 KD, 50.00 QR/SAR/AED, 5.00 BD/OMR  
 110, 120, 130  
 Colors:

 OFF WHITE  
 LIGHT PINK PATTERN  
 SAXE BLUE  
 OFF WHITE PATTERN



INDIAN COTTON JERSEY PRINTED T-SHIRT (KIDS)

Style No. CBG01A0S  
 5.00 KD, 60.00 QR/SAR/AED, 6.00 BD/OMR  
 110, 120, 130  
 Colors:

 DUGONG  SLOTH



INDIAN COTTON S/S PIQUE POLO SHIRT (KIDS)



Style No. CBI01A0S  
 6.00 KD, 80.00 QR/SAR/AED, 8.00 BD/OMR  
 110, 120, 130  
 Colors:

 NAVY  LIGHT BLUE  
 OFF WHITE



STRETCH JERSEY STITCH FULL LENGTH LEGGINGS PANTS (KIDS)

Style No. CBQ02A0S  
 3.00 KD, 40.00 QR/SAR/AED, 4.00 BD/OMR  
 110, 120, 130  
 Colors:

 BLACK  NAVY  
 MEDIUM GRAY



INDIAN COTTON JERSEY S/S T-SHIRT (KIDS)

Style No. CBR01A0S  
3.00 KD, 40.00 QR/SAR/AED, 4.00 BD/OMR  
110, 120, 130

Colors:  
LIGHT SILVER GRAY  
BLACK NAVY



DESIGN FOR COMFORT C&S DENIM EASY HALF PANTS (KIDS)

Style No. CBR02A0S  
11.00 KD, 130.00 QR/SAR/AED, 14.00 BD/OMR  
110, 120, 130, 140, 150

Colors:  
BLUE NAVY



BROAD STITCH JERSEY HALF PANTS (KIDS)

Style No. CBR04A0S  
3.00 KD, 40.00 QR/SAR/AED, 4.00 BD/OMR  
110, 120, 130, 140, 150

Colors:  
LIGHT GRAY  
BEIGE



INDIAN COTTON JERSEY PRINTED T-SHIRT

Style No. CCG01A0S  
5.00 KD, 60.00 QR/SAR/AED, 6.00 BD/OMR  
80, 90, 100

Colors:  
DUGONG SLOTH



INDIAN COTTON S/S PIQUE POLO SHIRT (BABY)

Style No. CCI01A0S  
6.00 KD, 80.00 QR/SAR/AED, 8.00 BD/OMR  
110, 120, 130, 140, 150

Colors:  
NAVY LIGHT BLUE  
OFF WHITE



STRETCH JERSEY STITCH FULL LENGTH LEGGINGS PANTS (BABY)

Style No. CCQ02A0S  
3.00 KD, 40.00 QR/SAR/AED, 4.00 BD/OMR  
110, 120, 130, 140, 150

Colors:  
BLACK NAVY  
MEDIUM GRAY



INDIAN COTTON JERSEY S/S T-SHIRT (BABY)

Style No. CCF01A0S  
5.00 KD, 60.00 QR/SAR/AED, 6.00 BD/OMR  
80, 90, 100

Colors:  
LIGHT SILVER GRAY



INDIAN COTTON JERSEY DOT S/S T-SHIRT (BABY)

Style No. CCF03A0S  
3.00 KD, 40.00 QR/SAR/AED, 4.00 BD/OMR  
80, 90, 100

Colors:  
PINK NAVY  
OFF WHITE



SLUB DROP SHOULDER S/S TSHIRT (BABY)

Style No. CCF11A0S  
4.00 KD, 50.00 QR/SAR/AED, 5.00 BD/OMR  
80, 90, 100

Colors:  
OFF WHITE  
LIGHT PINK PATTERN  
SAXE BLUE  
OFF WHITE PATTERN



BROAD STICTH FRAISE KNEE LENGTH LEGGINGS (BABY)

Style No. CCR01A0S  
3.00 KD, 40.00 QR/SAR/AED, 4.00 BD/OMR  
80, 90, 100

Colors:  
LIGHT SILVER GRAY  
BLACK NAVY



DESIGN FOR COMFORT C&S DENIM EASY HALF PANTS (BABY)

Style No. CCR02A0S  
11.00 KD, 130.00 QR/SAR/AED, 14.00 BD/OMR  
80, 90, 100

Colors:  
BLUE NAVY



BROAD STITCH JERSEY HALF PANTS (BABY)

Style No. CCR04A0S  
3.00 KD, 40.00 QR/SAR/AED, 4.00 BD/OMR  
80, 90, 100

Colors:  
LIGHT GRAY  
BEIGE





INDIAN COTTON JERSEY PRINTED T-SHIRT

Style No. E9AL015  
3.00 KD, 40.00 QR/SAR/AED, 4.00 BD/OMR  
110, 120, 130  
Colors



INDIAN COTTON JERSEY S/S T-SHIRT (KIDS)

Style No. E9AL500  
3.00 KD, 40.00 QR/SAR/AED, 4.00 BD/OMR  
110, 120, 130  
Colors:



STRETCH JERSEY STITCH FULL LENGTH LEGGINGS PANTS (BABY)

Style No. CCQ02A0S  
3.00 KD, 40.00 QR/SAR/AED, 4.00 BD/OMR  
110, 120, 130, 140, 150  
Colors:

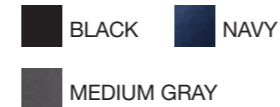

INDIAN COTTON JERSEY S/S T-SHIRT (BABY)

Style No. E9AM500  
3.00 KD, 40.00 QR/SAR/AED, 4.00 BD/OMR  
80, 90, 100  
Colors



INDIAN COTTON JERSEY PRINTED T-SHIRT (BABAY)

Style No. E9AM502  
5.00 KD, 60.00 QR/SAR/AED, 6.00 BD/OMR  
80, 90, 100  
Colors:

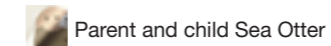

STRETCH JERSEY STITCH FULL LENGTH LEGGINGS PANTS (BABY)

Style No. E9AM506  
3.00 KD, 40.00 QR/SAR/AED, 4.00 BD/OMR  
80, 90, 100  
Colors:

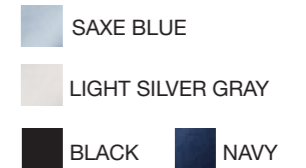

INDIAN COTTON JERSEY PRINTED T-SHIRT (KIDS)

Style No. E9AL502  
5.00 KD, 60.00 QR/SAR/AED, 6.00 BD/OMR  
110, 120, 130  
Colors:

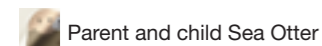

DESIGN FOR COMFORT C&S DENIM EASY HALF PANTS (BABY)

Style No. E9AL506  
3.00 KD, 40.00 QR/SAR/AED  
80, 90, 100  
Colors:

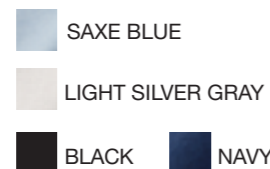

INDIAN COTTON MIX JERSEY STITCH PANTS (BABY)

Style No. E9AM015  
3.00 KD, 40.00 QR/SAR/AED, 4.00 BD/OMR  
80, 90, 100  
Colors:



INDIAN COTTON JERSEY PRINTED T-SHIRT (KIDS)

Style No. E9SL022  
5.00 KD, 60.00 QR/SAR/AED, 6.00 BD/OMR  
110, 120, 130, 140, 150  
Colors:

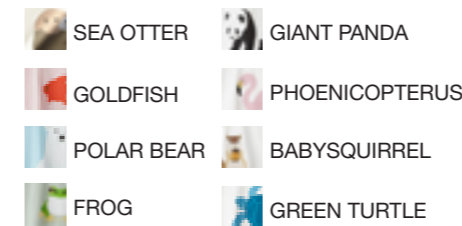

INDIAN COTTON JERSEY PRINTED T-SHIRT (BABAY)

Style No. E9SM022  
5.00 KD, 60.00 QR/SAR/AED, 6.00 BD/OMR  
80, 90, 100  
Colors:

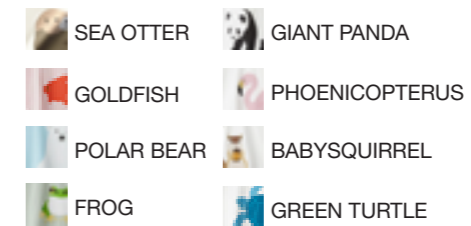



Pajamas



MEN'S SIDE SEAMLESS SEERSUCKER S/S PAJAMA

Style No. FBB3020S  
19.00 KD, 230.00 QR/SAR/AED, 23.00 BD/OMR  
S, M, L, XL

Colors:

-  BLUE STRIPE
-  NAVY STRIPE



MEN'S SIDE SEAMLESS WAFFLE S/S PAJAMA

Style No. FBB3120S  
19.00 KD, 230.00 QR/SAR/AED, 23.00 BD/OMR  
S, M, L, XL

Colors:

-  NAVY
-  GRAY



WOMEN'S SIDE SEAMLESS DOUBLE GAUZE PAJAMAS

Style No. FDA0120S  
19.00 KD, 220.00 QR, 230 SAR/AED, 23.00 BD/OMR  
XS, S, M, L

Colors:



-  OFF WHITE STRIPE



DOUBLE GAUZE KHURTA SLEEPER

Style No. FDA0220S  
19.00 KD, 220.00 QR, 230 SAR/AED, 23.00 BD/OMR  
XS, S, M, L

Colors:

-  NAVY CHECK
-  SMOKY BLUE STRIPE



WOMEN'S SIDE SEAMLESS SOFT SMOOTH PAJAMAS

Style No. FDA0320S  
19.00 KD, 230.00 QR/SAR/AED, 23.00 BD/OMR  
XS, S, M, L

Colors:

-  OFF WHITE
-  GRAY
-  PINK
-  DARK NAVY



WOMEN'S SIDE SEAMLESS DOUBLE GAUZE 3/4 SLEEVE PAJAMA

Style No. FDA1120S  
19.00 KD, 220.00 QR, 230 SAR/AED, 23.00 BD/OMR  
XS, S, M, L

Colors:

-  PINK
-  BLUE
-  LIGHT PINK STRIPE
-  NAVY STRIPE



ORGANIC LINEN KHURTA

Style No. FDA3020S  
19.00 KD, 230.00 QR/SAR/AED, 23.00 BD/OMR  
XS, S, M  
Colors:  
DARK GRAY  
RAW WHITE  
SMOKY BLUE CHECK



SIDE SEAMLESS DOUBLE GAUZE 3/4 SLEEVE KHURTA

Style No. FDA3120S  
19.00 KD, 220.00 QR, 230 SAR/AED, 23.00 BD/OMR  
XS, S, M  
Colors:  
NAVY CHECK  
CHARCOAL GRAY CHECK



WOMEN'S SIDE SEAMLESS SEERSUCKER S/S PAJAMA (CROPPED PANTS)

Style No. FDB0120S  
19.00 KD, 230.00 QR/SAR/AED, 23.00 BD/OMR  
XS, S, M, L  
Colors:  
PINK PATTERN  
NAVY PATTERN



ORGANIC LINEN KHURTA

Style No. U9AE201  
19.00 KD, 220.00 QR, 230 SAR/AED, 23.00 BD/OMR  
XS, S, M  
Colors:  
NAVY



SIDE SEAMLESS SMOOTH TRAINING PAJAMAS (BABY)

Style No. E9AP004  
9.00 KD, 110.00 QR/SAR/AED, 11.00 BD/OMR  
80-90, 90-100, 100-110  
Colors:  
GRAY BORDER  
NAVY BORDER



SIDE SEAMLESS SMOOTH PAJAMAS (KIDS)

Style No. E9AP005  
9.00 KD, 110.00 QR/SAR/AED, 11.00 BD/OMR  
110-125, 125-140  
Colors:  
GRAY BORDER  
NAVY BORDER



WOMEN'S SIDE SEAMLESS WOVEN WAFFLE S/S PAJAMA

Style No. FDB0220S  
19.00 KD, 230.00 QR/SAR/AED, 23.00 BD/OMR  
XS, S, M, L  
Colors:  
OFF WHITE  
SMOKY BLUE



SIDE SEAMLESS SOFT SMOOTH PAJAMA

Style No. U9AB201  
19.00 KD, 230.00 QR/SAR/AED, 23.00 BD/OMR  
XS, S, M, L  
Colors:  
DARK NAVY  
GRAY



SIDE SEAMLESS DOUBLE GAUZE PAJAMAS

Style No. U9AE200  
19.00 KD, 220.00 QR, 230 SAR/AED, 23.00 BD/OMR  
XS, S, M, L  
Colors:  
PINK CHECK  
MEDIUM GRAY  
PINK STRIPE



SIDE SEAMLESS DOUBLE GAUZE TRAINING PAJAMAS (BABY)

Style No. E9AP207  
9.00 KD, 110.00 QR/SAR/AED, 11.00 BD/OMR  
80-90, 90-100, 100-110  
Colors:  
PINK CHECK  
NAVY CHECK



SIDE SEAMLESS DOUBLE GAUZE PAJAMAS (KIDS)

Style No. E9AP208  
19.00 KD, 230.00 QR/SAR/AED, 23.00 BD/OMR  
110-125, 125-140  
Colors:  
PINK CHECK  
NAVY CHECK



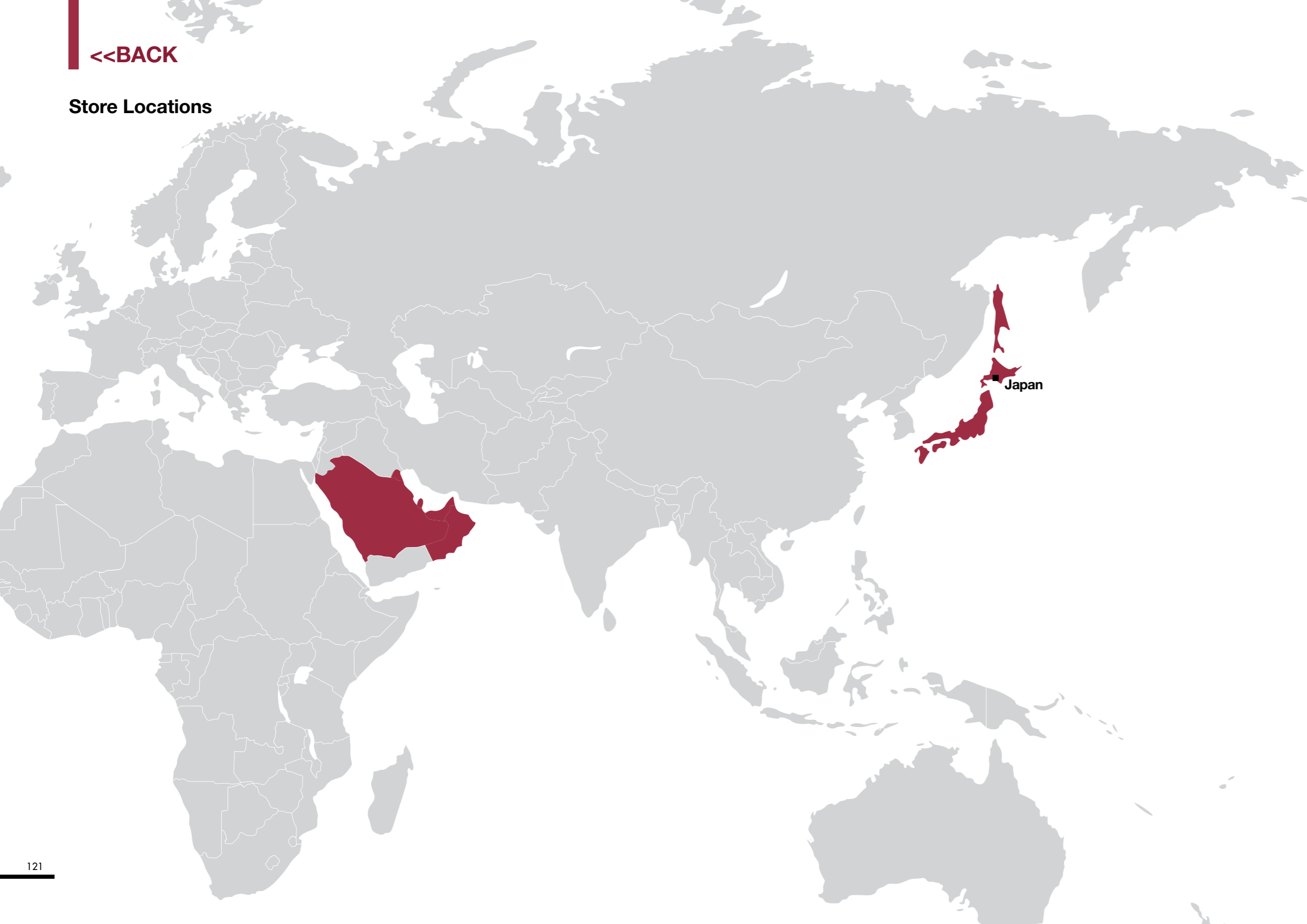

Over 800 stores around the world

1. UAE:

Dubai:

The Dubai Mall: (+971) 4 419 0205 / 06 / 07  
City Centre Mirdif: (+971) 4 419 0670 / 69 / 68  
The Beach, opposite JBR: (+971) 4 419 0868 / 69  
Mall of the Emirates (Debenham's Concession): (+971) 4 419 0472

Abu Dhabi:

Yas Mall: (+971) 2 492 6555 / 56 / 57  
Al Wahda Mall : (+971) 2 695 8230 / 40  
The Galleria, Al Maryah Island : (+971) 2 492 6790 / 91  
Jimi Mall: (+971) 3 701 8110 / 11

2. KSA

Red Sea Mall: (+966) 12 261 7474 / 79  
Hayat Mall: (+966) 11 510 1237 / 38  
Riyadh Gallery: (+966) 11 510 1491 / 90  
Riyadh Park: (+966) 11 520 3564 / 65  
Alrashid Mall: (+966) 13 667 8719

3. Kuwait

Grand Avenue - The Avenues: (+965) 2 228 3147 / 48  
2nd Avenue - The Avenues, First Floor: (+965) 2 228 3797 / 98  
Al Kout Mall: (+965) 2 208 1149 / 34

4. Qatar

Doha Festival City: (+974) 4 452 1463 / 64  
Villaggio: (+974) 4 452 9059/60

5. Bahrain

City Centre Bahrain: (+973) 1 711 0385 / 86  
The Avenues - Bahrain: (+973) 1 711 0561 / 62

6. Oman

Mall of Muscat: (+968) 22303560 / 61



-The selection of goods available may vary between individual stores.

-Size specifications represent gross external measurements and are for guidance only.

-If the size margin of a product is critical to your chosen function we recommend that you obtain accurate measurements instore.

-Please note that colours may vary slightly between catalogue image and actual product. Whilst every effort is made to ensure that all products featured are in constant supply, we apologise if any item is occasionally out of stock due to customer demand. Some items are seasonal and may only be stocked for short periods of time.

# MUJI online ecommerce

Coming soon.....

<https://www.alshaya.com/en/brands/fashion-footwear/muji/>

<http://www.muji.com/ae-en>